

Operating Instructions

Mini DV^{NTSC}

Digital Video Camera Recorder

Model No. AG-DVC7^P

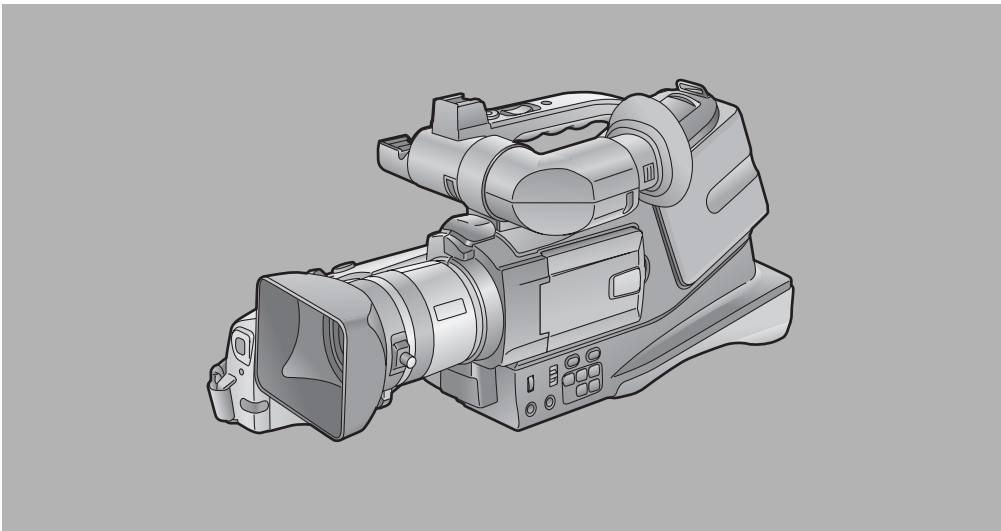

Panasonic[®]

Before operating this product, please read the instructions carefully and save this manual for future use.





Printed in Japan
S1202Y0 

VQT0C34

IMPORTANT

“Unauthorized recording of copyrighted television programs, video tapes and other materials may infringe the right of copyright owners and be contrary to copyright laws.”

	CAUTION RISK OF ELECTRIC SHOCK DO NOT OPEN	
CAUTION: TO REDUCE THE RISK OF ELECTRIC SHOCK, DO NOT REMOVE COVER (OR BACK). NO USER SERVICEABLE PARTS INSIDE. REFER TO SERVICING TO QUALIFIED SERVICE PERSONNEL.		



The lightning flash with arrowhead symbol, within an equilateral triangle, is intended to alert the user to the presence of uninsulated “dangerous voltage” within the product’s enclosure that may be of sufficient magnitude to constitute a risk of electric shock to persons.



The exclamation point within an equilateral triangle is intended to alert the user to the presence of important operating and maintenance (service) instructions in the literature accompanying the appliance.

WARNING:

TO REDUCE THE RISK OF FIRE OR SHOCK HAZARD, DO NOT EXPOSE THIS EQUIPMENT TO RAIN OR MOISTURE.

TO REDUCE THE RISK OF FIRE OR SHOCK HAZARD, KEEP THIS EQUIPMENT AWAY FROM ALL LIQUIDS-USE AND STORE ONLY IN LOCATIONS WHICH ARE NOT EXPOSED TO THE RISK OF DRIPPING OR SPLASHING LIQUIDS, AND DO NOT PLACE ANY LIQUID CONTAINERS ON TOP OF THE EQUIPMENT.

CAUTION:

TO REDUCE THE RISK OF FIRE OR SHOCK HAZARD AND ANNOYING INTERFERENCE, USE THE RECOMMENDED ACCESSORIES ONLY.

CAUTION:

Do not install or place this unit in a bookcase, built-in cabinet or any other confined space in order to maintain adequate ventilation. Ensure that curtains and any other materials do not obstruct the ventilation to prevent risk of electric shock or fire hazard due to overheating.

FCC Note:

This device complies with Part 15 of the FCC Rules. To assure continued compliance follow the attached installation instructions and do not make any unauthorized modifications.

This equipment has been tested and found to comply with the limits for a class A digital device, pursuant to Part 15 of the FCC Rules. These limits are designed to provide reasonable protection against harmful interference when the equipment is operated in a commercial environment. This equipment generates, uses, and can radiate radio frequency energy and, if not installed and used in accordance with the instruction manual, may cause harmful interference to radio communications. Operation of this equipment in a residential area is likely to cause harmful interference in which case the user will be required to correct the interference at his own expense.

CAUTION:

Danger of explosion or fire if battery is mistreated.

- Replace only with same or specified type.
- Do not disassemble or dispose of in fire.
- Do not store in temperatures over 60°C.
- Use specified charger for rechargeable batteries.
- Do not recharge the battery if it is not a rechargeable type.

For Remote Controller

- Replace battery with part No. CR2025 only.
- Do not recharge the battery.

 indicates safety information.

Important Safeguards

1. **Read Instructions** — All the safety and operating instructions should be read before the unit is operated.
2. **Retain Instructions** — The safety and operating instructions should be retained for future reference.
3. **Heed Warnings** — All warnings on the unit and in the operating instructions should be adhered to.
4. **Follow Instructions** — All operating and maintenance instructions should be followed.
5. **Cleaning** — Unplug this video unit from the wall outlet before cleaning. Do not use liquid or aerosol cleaners. Use a dry cloth for cleaning.
6. **Attachments** — Do not use attachments not recommended by the video product manufacturer as they may be hazardous.
7. **Water and Moisture** — Do not use this video unit near water — for example near a bath tub, wash bowl, kitchen sink, or laundry tub, in a wet basement, or near a swimming pool, and the like.
8. **Accessories** — Do not place this video unit on an unstable cart, stand, tripod, bracket, or table. The video unit may fall, causing serious injury to a child or adult, and serious damage to the unit. Use only with a cart, stand, tripod, bracket, or table recommended by the manufacturer, or sold with the video unit. Any mounting of the unit should follow the manufacturer's instructions and should use a mounting accessory recommended by the manufacturer. An appliance and cart combination should be moved with care. Quick stops, excessive force, and uneven surfaces may cause the appliance and cart combination to overturn.
9. **Ventilation** — Slots and openings in the cabinet are provided for ventilation and to ensure reliable operation of the video unit and to protect it from overheating. These openings must not be blocked or covered. Never place the video unit on a bed, sofa, rug, or other similar surface, or near or over a radiator or heat register. This video unit should not be placed in a built-in installation such as a bookcase or rack unless proper ventilation is provided or the manufacturer's instructions have been adhered to.
10. **Power Sources** — This video unit should be operated only from the type of power source indicated on the marking label. If you are not sure of the type of power supply to your home, consult your appliance dealer or local power company. For video units intended to be operated from battery power, or other sources, refer to the operating instructions.
11. **Grounding or Polarization** — This video unit may be equipped with either a polarized 2-wire AC (Alternating Current) line plug (a plug having one blade wider than the other) or 3-wire grounding type plug, a plug having a third (grounding) pin.
The 2-wire polarized plug will fit into the power outlet only one way. This is a safety feature. If you are unable to insert the plug fully into the outlet, try reversing the plug. If the plug still fails to fit, contact your electrician to replace your obsolete outlet. Do not defeat the safety purpose of the polarized plug.
The 3-wire grounding type plug will fit into a grounding type power outlet. This is a safety feature. If you are unable to insert the plug into the outlet, contact your electrician to replace your obsolete outlet. Do not defeat the safety purpose of the grounding type plug.
12. **Power-Cord Protection** — Power-supply cords should be routed so that they are not likely to be walked on or pinched by items placed upon or against them, paying particular attention to cords of plugs, convenience receptacles, and the point where they exit from the unit.



Important Safeguards

13. **Outdoor Antenna Grounding** — If an outside antenna or cable system is connected to the video unit, be sure the antenna or cable system is grounded so as to provide some protection against voltage surges and built-up static charges. Part 1 of the Canadian Electrical Code, in USA Section 810 of the National Electrical Code, provides information with respect to proper grounding of the mast and supporting structure, grounding of the lead-in wire to an antenna discharge unit, size of grounding conductors, location of antenna discharge unit, connection to grounding electrodes, and requirements for the grounding electrode.

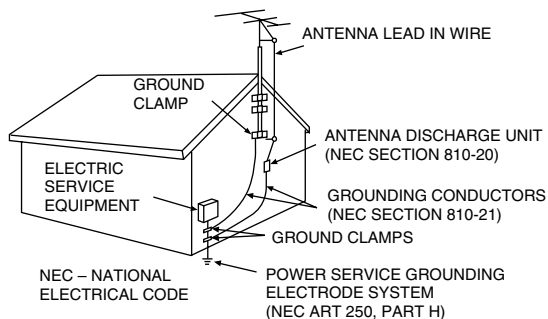

14. **Lightning** — For added protection of this video unit receiver during a lightning storm, or when it is left unattended and unused for long periods of time, unplug it from the wall outlet and disconnect the antenna or cable system. This will prevent damage to the video unit due to lightning and power-line surges.
15. **Power Lines** — An outside antenna system should not be located in the vicinity of overhead power lines or other electric light or power circuits, or where it can fall into such power lines or circuits. When installing an outside antenna system, extreme care should be taken to keep from touching such power lines or circuits as contact with them might be fatal.
16. **Overloading** — Do not overload wall outlets and extension cords as this can result in a risk of fire or electric shock.
17. **Objects and Liquids** — Never push objects of any kind into this video unit through openings as they may touch dangerous voltage points or short out parts that could result in a fire or electric shock. Never spill liquid of any kind onto the video unit.
18. **Servicing** — Do not attempt to service this video unit yourself as opening or removing covers may expose you to dangerous voltage or other hazards. Refer all servicing to qualified service personnel.
19. **Damage Requiring Service** — Unplug this video unit from the wall outlet and refer servicing to qualified service personnel under the following conditions:
- When the power-supply cord or plug is damaged.
 - If any liquid has been spilled onto, or objects have fallen into the video unit.
 - If the video unit has been exposed to rain or water.
 - If the video unit does not operate normally by following the operating instructions. Adjust only those controls that are covered by the operating instructions, as an improper adjustment of other controls may result in damage and will often require extensive work by a qualified technician to restore the video unit to its normal operation.
 - If the video unit has been dropped or the cabinet has been damaged.
 - When the video unit exhibits a distinct change in performance – this indicates a need for service.
20. **Replacement Parts** — When replacement parts are required, be sure the service technician has used replacement parts specified by the manufacturer or have the same characteristics as the original part. Unauthorized substitutions may result in fire, electric shock or other hazards.
21. **Safety Check** — Upon completion of any service or repairs to this video unit, ask the service technician to perform safety checks to determine that the video unit is in safe operating order.

FCC Warning: Any unauthorized changes or modifications to this equipment would void the user's authority to operate.

As this equipment gets hot during use, operate it in a well-ventilated place; do not install this equipment in a confined space such as a bookcase or similar unit.

To reduce the risk of fire, electric shock or product damage, do not expose this equipment to rain, moisture, dripping or splashing and ensure that no objects filled with liquids, such as vases, shall be placed on the equipment.

Camera Recorder

- The rating plate is on the underside of the Camera Recorder.

AC Adaptor

- The rating plate is on the underside of the AC Adaptor.

■ Carefully read the Operating Instructions and use the Camera Recorder correctly.

- **Injury or material damage resulting from any kind of use that is not in accordance with the operating procedures explained in these Operating Instructions are the sole responsibility of the user.**

Try out the Camera Recorder.

Be sure to try out the Camera Recorder before recording your first important event and check that it records properly and functions correctly.

The manufacturer is not liable for loss of recorded contents.

The manufacturer shall in no event be liable for the loss of recordings due to malfunction or defect of this Camera Recorder, its accessories or cassettes.

Carefully observe copyright laws.

Recording of pre-recorded tapes or discs or other published or broadcast material for purposes other than your own private use may infringe copyright laws. Even for the purpose of private use, recording of certain material may be restricted.

- All company and product names in the operating instructions are trademarks or registered trademarks of their respective corporations.

Pages for reference

Pages for reference are indicated by dashes either side of a number, for example: -00-

■ WARNING

To prevent electric shock, do not remove the cover (or back); there are no user serviceable parts inside.

Refer servicing to qualified service personnel.

Use only the recommended accessories.

■ Notes about Video Head Clogging

- When the Camera Recorder's video heads have become clogged with dirt (dust and tape coating particles), the [⊗] Indication appears. In addition, the playback picture (A) is distorted with mosaic-like patterns (1 or 2). When the clogging further worsens, the whole screen may be black during playback 3.
- To clean video heads that have become clogged with dirt, use the Digital Video Head Cleaner.
- If you want to purchase the same Digital Video Head Cleaner, please contact your Panasonic dealer to obtain it from the Panasonic spare parts department (part number VFK1451).
- If the video heads again become clogged with dirt soon after cleaning, this might be caused by damaged tape. In this case, stop using that cassette. We recommend that you use Panasonic cassettes.

Contents

Standard Accessories	7	Playing Back	32
Optional Accessories	7	Finding a Scene You Want to Play Back	33
Controls and Components	8	Slow Motion Playback	33
The Remote Controller	11	Still Playback/Still Advance Playback	34
Power Supply	12	Finding the End of Recording	34
Charging Time and Available Recording Time	13	Index Search Functions	35
Lens Cap and Grip Belt	13	Playback Zoom Function	36
Attaching the Shoulder Strap	13	Playback Digital Effect Functions	36
Inserting a Cassette	14	Playing Back on Your TV	37
Turning on the Camera Recorder and Selecting Modes	14	Audio Dubbing	38
Using the Viewfinder/LCD Monitor	15	Copying on an S-VHS (or a VHS) Cassette	39
Using the Menu Screen	16	Recording the Contents of Other Equipment	39
List of Menus	16	Using the DV Cable for Recording	40
Setting Date and Time	18	Indications	41
Internal Lithium Battery Recharge	18	Warning/Alarm Indications	42
LP Mode	18	Notes and Hints	42
Audio Recording Mode	18	Cautions for Use	46
Holding the Camera Recorder for Recording	19	Before Requesting Repair (Problems and Solutions)	50
Recording	20	Explanation of Terms	52
Photoshot	22	Specifications	53
Zoom In/Out Functions	23		
Digital Zoom Function	23		
Image Stabilizer Function	24		
Fade In/Out Functions	24		
Backlight Compensation Function	25		
Wind Noise Reduction Function	25		
Cinema Function	25		
Recording in Special Situations	26		
Recording in Natural Colors	26		
Adjusting White Balance Manually	27		
Manual Shutter Speed Adjustment	28		
Manual Iris Adjustment	28		
Manual Focus Adjustment	29		
Picture Effect Functions	29		
Adjusting the Microphone Sensitivity Level	31		

Standard Accessories

Optional Accessories

Illustrated are accessories supplied with the Camera Recorder.

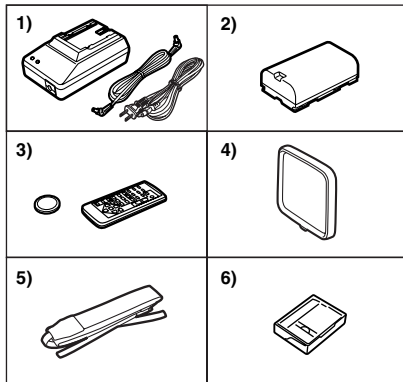

- 1) **AC Adaptor, DC Input Lead and AC Mains Lead -12-**
- 2) **Battery Pack -12-**
- 3) **Remote Controller and Button-Type Battery -10-, -11-**
- 4) **Lens Cap -13-**
- 5) **Shoulder Strap -13-**
- 6) **Digital Video Head Cleaner -47-**

- 1) AC Adaptor (AG-B15)
 - 2) Stereo Microphone (AG-MC15)
 - 3) Battery Pack (Lithium/CGR-D16/CGR-D220/1600mAh)
 - 4) Battery Pack (Lithium/CGP-D28/CGP-D320/2800mAh)
 - 5) Wide Conversion Lens (AG-LW4307)
- Some optional accessories may not be available in some countries.

Controls and Components

■ Camera Recorder

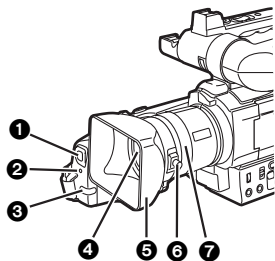

- 1 White Balance Sensor -27-
- 2 Recording Lamp -20-
- 3 Remote Control Sensor -11-
- 4 Lens
- 5 Lens Hood -49-
- 6 Lens Hood Attachment knob -49-
- 7 Focus Ring -29-

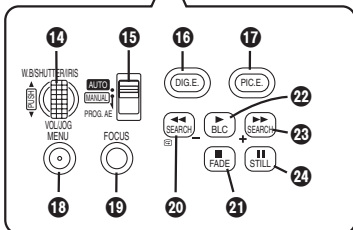
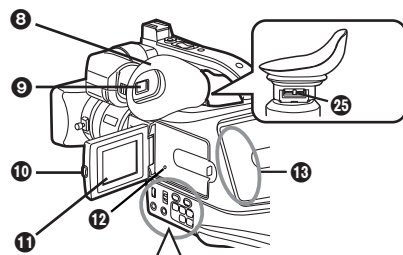

- 8 Eyecup -49-
- 9 Viewfinder -15-, -49-

- Due to limitations in LCD production technology, there may be some tiny bright or dark spots on the Viewfinder screen. However, this is not a malfunction and does not affect the recorded picture.

- 10 LCD Monitor Open Button [PUSH OPEN] -15-
- 11 LCD Monitor -15-, -49-

- Due to limitations in LCD production technology, there may be some tiny bright or dark spots on the LCD Monitor screen. However, this is not a malfunction and does not affect the recorded picture.

- 12 Reset Button [RESET] -42-
- 13 Speaker -32-
- 14 Multi-Function Dial [PUSH] -16-, -26-, -32-
- 15 Mode Selector Switch [AUTO/MANUAL/PROG.AE] -20-, -26-
- 16 Digital Effect Button [DIG.E.] -24-

- 17 Picture Effect Button [PIC.E.] -29-
- 18 Menu Button [MENU] -16-
- 19 Focus Button [FOCUS] -29-
- 20 Rewind/Review Button [◀◀] -32-
- Reverse Search Button [SEARCH -] -20-
- Recording Check Button [RECORD] -20-
- 21 Stop Button [■] -32-
- Fade Button [FADE] -24-
- 22 Play Button [▶] -32-
- Backlight Button [BLC] -25-
- 23 Fast Forward/Cue Button [▶▶] -32-
- Forward Search Button [SEARCH +] -20-
- 24 Pause Button [||] -34-
- Still Button [STILL] -22-
- 25 Eyepiece Corrector Knob -15-

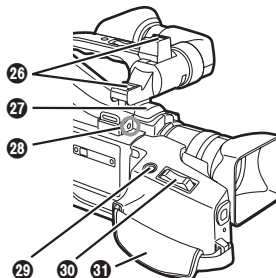

- 26 Smart Accessory Shoes
 - The External Stereo Microphone (option), etc. can be attached here.
- 27 Microphone (built-in, stereo) -23-
- 28 External Microphone Socket [EXT MIC]
 - Connect with an external microphone or audio equipment. (When this socket is in use, the built-in microphone does not operate.)
- 29 Photoshot Button [PHOTO SHOT] -22-
- 30 Zoom Lever [W/T] -23-
- 31 Grip Belt -13-

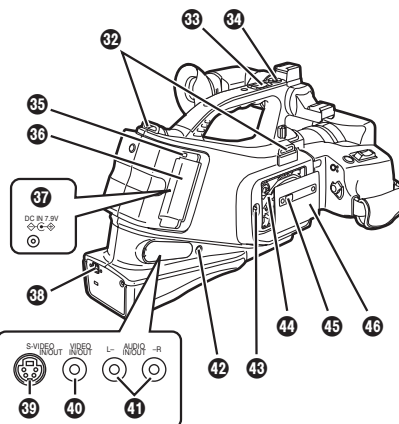

- 32 Shoulder Strap Holders -13-
- 33 Sub Zoom Lever [W/T] -19-
- 34 Sub Recording Start/Stop Button -19-
- 35 Battery Eject Button [PUSH] -12-
- 36 Battery Holder
- 37 DC Input Socket [DC IN] -12-
- 38 DV Terminal [DV] -40-
 - Connect this to the digital video equipment.

Controls and Components

■ Camera Recorder

- ③⑨ S-Video Input/Output Socket [S-VIDEO IN/OUT]
-37-, -39-
- ④⑩ Video Input/Output Socket [VIDEO IN/OUT]
-37-, -39-
- ④⑪ Audio Input/Output Sockets [AUDIO IN/OUT]
-37-, -39-
- ④⑫ Headphone Socket [PHONES] -44-
- ④⑬ Cassette Eject Lever [▲EJECT] -14-
- ④⑭ Cassette Holder
- ④⑮ Cassette Compartment Lock Button
[PUSH LOCK] -14-
- ④⑯ Cassette Compartment Cover -14-

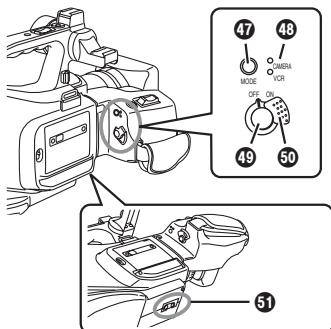

- ④⑰ Mode Button [MODE] -32-
- ④⑱ Operation Mode Lamps [CAMERA/VCR]
-14-, -20-, -32-
- ④⑲ Recording Start/Stop Button -20-
- ④⑳ Off/On Switch [OFF/ON] -14-, -20-, -46-
- ⑤① Tripod Receptacle
 - Used for mounting the Camera Recorder on a tripod.

Controls and Components

Remote Controller

Using the wireless Remote Controller that is supplied with the Camera Recorder, most of the Camera Recorder functions can be operated from a distance.

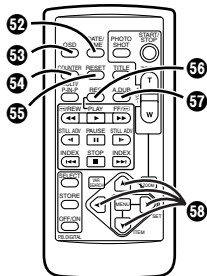

- 52 Date/Time Button [DATE/TIME] -41-
- 53 Indication Output Button [OSD] -37-
- 54 Counter Indication Shift Button [COUNTER] -41-
- 55 Reset Button [RESET] -52-
- 56 Recording Button [REC] -39-, -40-
- 57 Audio Dubbing Button [A.DUB] -38-
- 58 Cursor Buttons for Variable Speed Search Function [▲, ▼] -33-
Direction Buttons for Playback Zoom Function [▲, ▼, ◀, ▶] -36-

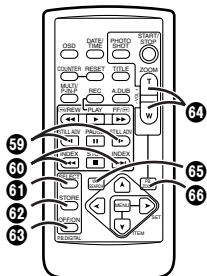

- 59 Slow Motion/Still Advance Buttons [◀, ▶] (◀: reverse, ▶:forward) -33-
- 60 Index Search Buttons [◀◀, ▶▶] (◀◀: reverse, ▶▶:forward) -35-
- 61 Selection Button [SELECT] -36-
- 62 Store Button [STORE] -36-
- 63 Off/On Button [OFF/ON] -36-
- 64 Zoom/Volume Button [ZOOM/VOL] -23-, -32-, -36-
- 65 Variable Speed Search Button [VAR. SEARCH] -33-
- 66 Playback Zoom Button [P.B. ZOOM] -36-

The following buttons function in the same manner as the corresponding buttons on the Camera Recorder.

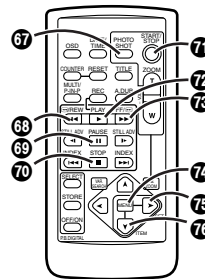

- 67 Photoshot Button [PHOTO SHOT] -22-
- 68 Rewind/Review Button [◀◀] -20-, -33-
- 69 Pause Button [||] -34-
- 70 Stop Button [■] -32-
- 71 Recording Start/Stop Button [START/STOP] -20-
- 72 Play Button [▶] -32-
- 73 Fast-forward/Cue Button [▶▶] -32-
- 74 Menu Button [MENU] -16-
- 75 Set Button [SET] -16-
- 76 Item Button [ITEM] -16-

The Remote Controller

■ Inserting a Button-type Battery

Before using the Remote Controller, insert the supplied button-type battery.

1 While pressing the Stopper ①, pull out the Battery Holder.

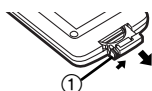

2 Insert the button-type battery with the (+) marking facing upward.



3 Insert the Battery Holder into the Remote Controller.

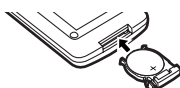

- When the button-type battery is exhausted, replace it with a new CR2025 battery. (A battery is normally expected to last about 1 year. However, it depends on operation frequency.)
- Make sure to match the poles correctly when inserting the battery.

CAUTION

Danger of explosion if battery is incorrectly replaced. Replace only with the same or equivalent type recommended by the equipment manufacturer. Discard used batteries according to manufacturer's instructions.

WARNING

Risk of fire, explosion and burns. Do not recharge, disassemble, heat above 60°C or incinerate. Keep the Button-Type battery out of the reach of children. Never put Button-Type battery in mouth. If swallowed call your doctor.

■ Using the Remote Controller

1 Direct the Remote Controller to the Remote Control Sensor ③ of the Camera Recorder and press an appropriate button.

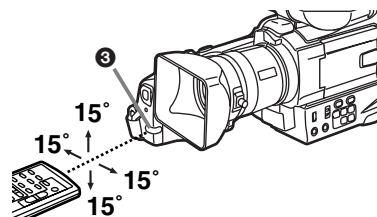

- Distance from the Camera Recorder:
Within approximately 5 metres
- Angle:
Within approximately 15° in the vertical and horizontal directions from the central axis
- The above operative ranges are for indoor use. Outdoors or under strong light, the Camera Recorder may not operate properly even within the above ranges.
- Within a 1-metre range, you can also use the Remote Controller on the LCD Monitor side of the Camera Recorder.

Selecting Remote Controller Modes

When 2 Movie Cameras are used simultaneously, they can be operated individually by selecting different Remote Controller Modes.

- If the Remote Controller Mode of the Camera Recorder and that of the Remote Controller do not match, [REMOTE] Indication is displayed.

Setup on the Camera Recorder:

Set [REMOTE] on the [OTHER FUNCTIONS] Sub-Menu to the desired Remote Controller Mode. (-I6-)

Setup on the Remote Controller:

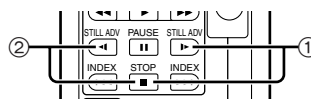

[VCR1]:

Press the [▶] Button and [■] Button simultaneously. ①

[VCR2]:

Press the [◀] Button and [■] Button simultaneously. ②

- When the battery in the Remote Controller is replaced, the mode is automatically reset to [VCR1] Mode.

Power Supply

■ Using the AC Adaptor

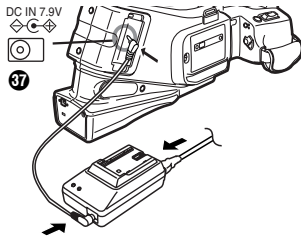

- 1 Connect the AC Mains Lead to the AC Adaptor and the AC mains socket.
- 2 Connect the DC Input Lead to the [DC IN] Socket 37 on the Camera Recorder.
- 3 Connect the DC Input Lead to the AC Adaptor.

- Before connecting or disconnecting the power supply, set the [OFF/ON] Switch on the Camera Recorder to [OFF] and make sure that [CAMERA/VCR] Lamps is not lit.

■ Using the Battery

Before use, fully charge the Battery.

- 1 Attach the Battery to the AC Adaptor and charge it.

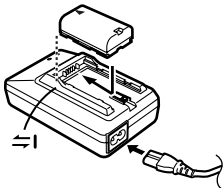

- Since the Battery will not be charged when the DC Input Lead is connected to the AC Adaptor, disconnect it from the AC Adaptor.
 - The [CHARGE] Lamp lights up, and charging starts.
 - When the [CHARGE] Lamp goes off, charging is completed.
- 2 Attach the charged Battery to the Camera Recorder.

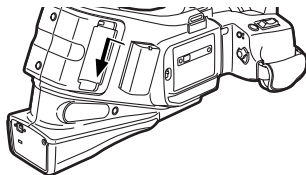

Disconnecting the Power Source

Set the [OFF/ON] Switch 50 to [OFF] and, disconnect the DC Input Lead or remove the Battery.

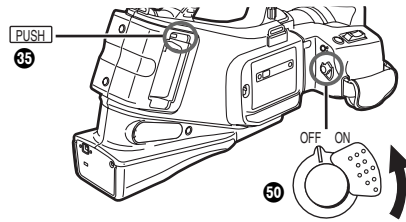

- While pressing the [PUSH] Button 35 with your index, remove the battery by pushing it up with your thumb.

CAUTION:

This unit will operate on 110/120/220/240V AC. An AC plug adapter may be required for voltages other than 120V/AC.

If a conversion plug is required, consult with your dealer as to which one is to be purchased.

- For other notes concerning this item, see -42-.

- **Do not bring metal objects (such as necklaces or hairpins) into contact with the battery terminals. The terminals may short circuit and generate heat, and touching them in this condition may cause severe burns.**
- The battery heats up during operation and during charging, as does the camera recorder body.
- If recording and stop operations are repeated more than is necessary, the recording time will be less than the values given in the above table.
- Store the battery only when it is fully discharged. It is recommended that the battery be charged once a year when it is being stored long-term and that it be placed back in storage after it has been fully discharged using the camera recorder.
- When the temperature of the battery unit has risen to an extremely high level or dropped to an extremely low level or when the battery is not used for prolonged periods of time has become fully discharged, the "CHARGE" lamp flashes several times, and charging commences automatically.
- If the "CHARGE" lamp continues to flash even though the battery temperature is normal, consult your dealer as a problem may have developed within the battery or AC adapter.
- When the battery is warm, it takes longer than usual for the battery to be charged.
- When the AC adapter is used near a radio, the radio sound may be distorted. Use the adapter at a distance of at least one meter from the radio.
- Noise may be heard while the AC adapter is in use; however, this is normal and not indicative of any malfunctioning.
- The battery cannot be charged while supplying power from the AC adapter to the camera recorder.

Charging Time and Available Recording Time

Battery supplied	Ⓐ	2h.
	Ⓑ	3h30min. (2h55min.)
	Ⓒ	1h45min. (1h30min.)
CGP-D28	Ⓐ	3h15min.
	Ⓑ	6h5min. (5h)
	Ⓒ	3h (2h30min.)

Ⓐ Charging Time

Ⓑ Maximum Continuous Recording Time

Ⓒ Intermittent Recording Time

(Intermittent Recording Time is the available recording time with repeated recording and stopping actions.) "1h10min." indicates 1 hour and 10 minutes.

- The times shown in the table are approximate times. The numbers in parentheses indicate the recording time when the LCD Monitor is used. In actual use, the available recording time may be shorter.
- The times shown in the table are for continuous recording at a temperature of 20°C and humidity of 60%. If the Battery is charged at a higher or lower temperature, the charging time may be longer.

Lens Cap and Grip Belt

■ Attach the Lens Cap

To protect the Lens surface, attach the Lens Cap.

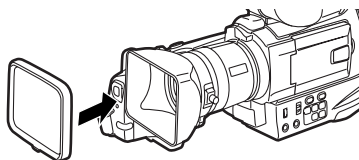

■ Adjust the Grip Belt

Adjust the length of the Grip Belt to the size of your hand.

1 Detach the tip of the Grip Belt.

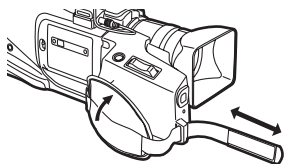

2 Adjust the length.

3 Reattach the Grip Belt.

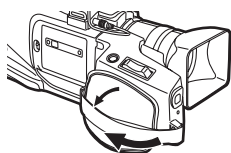

Attaching the Shoulder Strap

We recommend that you attach the Shoulder Strap before going out of doors to record so as to avoid dropping the Camera Recorder.

1 Pull the end of the Shoulder Strap through the Shoulder Strap Holder on the Camera Recorder.

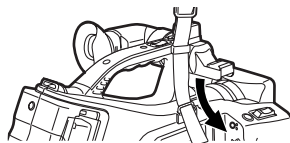

2 Fold the tip of the Shoulder Strap, run it through the Shoulder Strap Length Adjuster, and pull it.

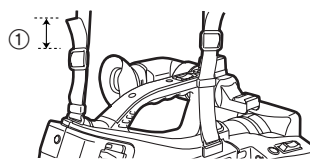

- Pull it out more than 1.5 inch ① from the Shoulder Strap Length Adjuster so that it cannot slip off.

Inserting a Cassette

1 Slide the [▲EJECT] Lever 43 to open the Cover.

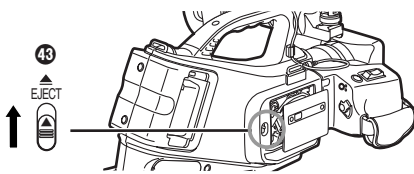

2 Insert a Cassette.

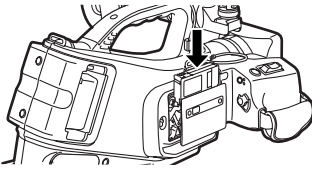

3 Close the Cover and press the [PUSH LOCK] Button 45 to lock the cover.

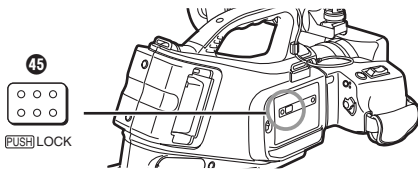

Accidental Erasure Prevention

Opening the accidental erasure prevention slider ① on the cassette (by sliding it in the [SAVE] arrow direction) prevents the tape from recording. To enable recording, close the accidental erasure prevention slider (by sliding it in the [REC] arrow direction).

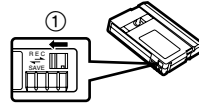

• For other notes concerning this item, see -42-.

Turning on the Camera Recorder and Selecting Modes

Turn on the power first and then select modes.

How to Turn on the Power

1 Set the [OFF/ON] Switch 50 to [ON].

- The [CAMERA] Lamp 48 lights up.

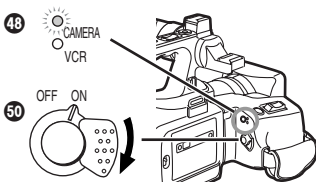

How to Turn off the Power

3 Set the [OFF/ON] Switch 50 to [OFF].



How to Switch Modes

2 Press the [MODE] Button 47.

- With each press, the Mode changes.
- The appropriate Mode Lamp lights up.

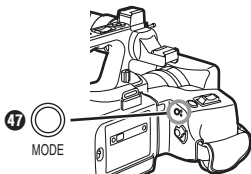

Using the Viewfinder/LCD Monitor

■ Using the Viewfinder

Before using the Viewfinder, adjust the field of view so that the displays inside the Viewfinder become clear and easy to read.

I Pull out the Viewfinder and tilt it up.

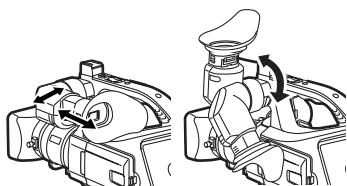

- The angular part of the Viewfinder can be turned upward by 80° and downward by 38°.
- Do not pull on the Eyecup to extend the Viewfinder.

2 Adjust by sliding the Eyepiece Corrector Knob 25.

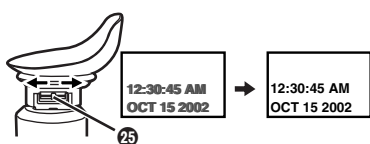

■ Using the LCD Monitor

With the LCD Monitor open, you can also record the picture while watching it.

I Press the [PUSH OPEN] Button 10 and, at the same time, bring the LCD Monitor 11 out about 90° in the direction of the arrow.

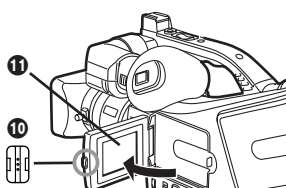

- The Viewfinder goes off.

2 Adjust the LCD Monitor angle according to the desired recording angle.

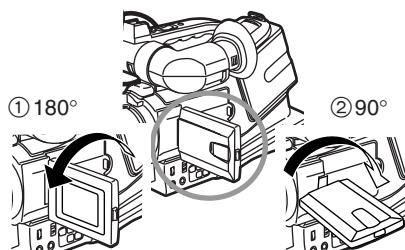

- The LCD Monitor can rotate a maximum of 180° ① from the vertical position to the upward direction and a maximum of 90° ② to the downward direction. Forcefully rotating the LCD Monitor beyond these ranges will damage the Camera Recorder.
- When you open the LCD Monitor, be sure that the LCD Monitor and the Viewfinder cannot touch.

Closing the LCD Monitor

Push the LCD Monitor until it is securely locked.

■ Adjusting Brightness and Color Level

When [LCD/EVF SET] on the [DISPLAY SETUP] Sub-Menu is set to [YES], the following items are displayed.

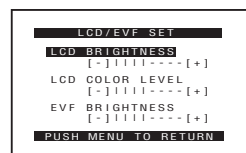

LCD Brightness [LCD BRIGHTNESS]

It adjusts the brightness of the image on the LCD screen.

LCD Color Level [LCD COLOR LEVEL]

It adjusts the color saturation of the image on the LCD screen.

Brightness of the Viewfinder [EVF BRIGHTNESS]

It adjusts the brightness of the image in the Viewfinder.

To Adjust

Press the [PUSH] Dial and select the item to be adjusted, and then turn the [PUSH] Dial to raise or lower the number of vertical bars in the Bar Indication.

- A larger number of vertical bars indicates stronger brightness or color saturation.

Increasing the Brightness of the Entire LCD Monitor

Set the [LCD MODE] on the [DISPLAY SETUP] Sub-Menu to [BRIGHT].

- These adjustments do not affect the recorded images.

- For other notes concerning this item, see -49-.

Using the Menu Screen

To facilitate the selection of a desired function or setup, this Camera Recorder displays various function setups on Menus.

1 Press the [MENU] Button 18.

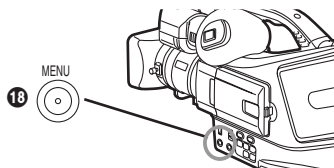

- The Menu corresponding to the Mode selected by using the [MODE] Button 47 is displayed.

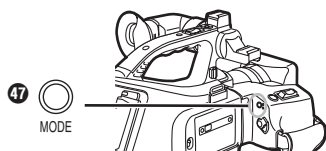

2 Turn the [PUSH] Dial 14 to select a desired Sub-Menu.

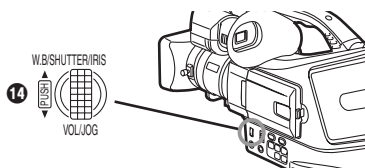

- Turn the [PUSH] Dial 14 to display the highlighted item.

3 Press the [PUSH] Dial 14 to display the selected Sub-Menu.

4 Turn the [PUSH] Dial 14 to select the item to be set.

5 Press the [PUSH] Dial 14 to set the selected item to a desired mode.

- With each press of the [PUSH] Dial, the cursor [▶] moves to the next mode. Menu items that cannot be used in combination with the selected item are displayed in dark blue.
- While a Menu is displayed, you cannot record or play back. Menus can be displayed during playback but not during recording. The above operations can be done using the [MENU] Button, [SET] Button and [ITEM] Button on the Remote Controller. (-11-)

To Exit the Menu Screen

Press the [MENU] Button again.

About the Menu Mode Setting

The setting selected on the Menu will be retained even when the Camera Recorder is turned off. However, if the Battery or AC Adaptor is disconnected before turning off the Camera Recorder, the selected setup may not be retained. (But, the setups of [NEGA], [SEPIA], [MONO] or [SOLARI] (-29-) are not retained.)

- Menu operation flow is shown in this text by >>.

List of Menus

The figures of the Menus are for explanation purposes only, and they are different from the actual Menus.

■ [CAMERA FUNCTIONS]

Camera Mode Main-Menu

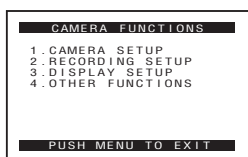

[1. CAMERA SETUP]

Camera Setup Sub-Menu

[PROGRESSIVE]

Progressive Photoshot Mode -22-

[D.ZOOM]

Digital Zoom -23-

[CINEMA]

Cinema-like Format Recording -25-

[P.EFFECT]

Picture Effects -29-

[RETURN]

Returning to the Main-Menu

- If you set [RETURN] to [YES], the menu changes back to the Main-Menu.

[2. RECORDING SETUP]

Recording Setup Sub-Menu

[REC SPEED]

Recording Speed Mode -18-

[AUDIO REC]

Audio Recording Mode -18-

[SCENEINDEX]

Scene Index Mode -35-

[WIND CUT]

Wind Noise Reduction -25-

[ZOOM MIC]

Zoom Microphone -23-

[MIC LEVEL ADJ.]

Microphones Sensitivity Level -31-

[RETURN]

Returning to the Main-Menu

List of Menus

[3. DISPLAY SETUP]

Display Setup Sub-Menu

[DATE/TIME]

Date and Time Indication -41-

[C.DISPLAY]

Counter Display Mode -41-

[C.RESET]

Counter Reset -52-

- It resets the counter to zero. However, it cannot reset the Time Code.

[DISPLAY]

Display Mode -41-

[LCD MODE]

LCD Lighting Mode -15-

[LCD/EVF SET]

LCD and Viewfinder Adjustment -15-

[RETURN]

Returning to the Main-Menu

[4. OTHER FUNCTIONS]

Other Functions Sub-Menu

[REMOTE]

Remote Controller Mode -11-

[REC LAMP]

Recording Lamp -20-

[BEEP SOUND]

Beep Sound -42-

[SHTR EFFECT]

Shutter Effect -22-

[CLOCK SET]

Date and Time Setting -18-

[SELF REC]

Recording Yourself -21-

[RETURN]

Returning to the Main-Menu

■ [VCR FUNCTIONS]

VCR Mode Main-Menu

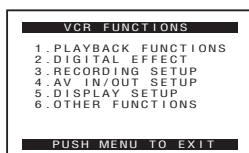

[1. PLAYBACK FUNCTIONS]

Playback Functions Sub-Menu

[BLANK SEARCH]

Blank Search -34-

[SEARCH]

Index Search Mode -35-

[12bit AUDIO]

Audio Selector -38-

[AUDIO OUT]

Audio Output Mode -44-

[RETURN]

Returning to the Main-Menu

[2. DIGITAL EFFECT]

Playback Digital Effect Functions Sub-Menu

[EFFECT]

Digital Effect On/Off -36-

[EFFECT SELECT]

Digital Effect Selection -36-

[RETURN]

Returning to the Main-Menu

[3. RECORDING SETUP]

Recording Setup Sub-Menu

[REC SPEED]

Recording Speed Mode -18-

[AUDIO REC]

Audio Recording Mode -18-

[AUDIO LEVEL]

Audio Level Setting -38-

[RETURN]

Returning to the Main-Menu

[4. AV IN/OUT SETUP]

Audio-Video Input/Output Setup Sub-Menu

[AV JACK]

AV Socket -38-

[A.DUB INPUT]

Audio Dubbing Input -38-

[DV OUT]

Analog-Digital Conversion Output -45-

[RETURN]

Returning to the Main-Menu

[5. DISPLAY SETUP]

Display Setup Sub-Menu

- All of the items on the [DISPLAY SETUP] Sub-Menu are the same as those on the [DISPLAY SETUP] Sub-Menu of the [CAMERA FUNCTIONS] Main-Menu.

[6. OTHER FUNCTIONS]

Other Functions Sub-Menu

[REMOTE]

Remote Controller Mode -11-

[CLOCK SET]

Date and Time Setting -18-

[RETURN]

Returning to the Main-Menu

Setting Date and Time

Since the internal clock of the Camera Recorder has a slight imprecision, make sure to check the time before recording.

1 Set [OTHER FUNCTIONS] >> [CLOCK SET] >> [YES].

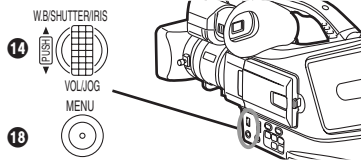

2 Press the [PUSH] Dial 14 to select [YEAR]/[MONTH]/[DAY]/[HOUR]/[MINUTE] and turn to set it to a desired value.

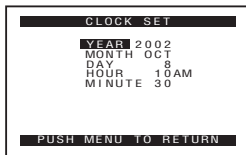

- Year will cycle in the order shown below.
2000, 2001, ..., 2089, 2000, ...

3 Press the [MENU] Button 18 to finish setting the date and time.

- The clock operation starts from [00] second.
- The Menu will disappear when the [MENU] Button is pressed again.
- If the built-in battery is weak, the Date/Time Indication becomes [--]. In this case, charge the built-in battery.
- The clock employs the 12-hour system.

Internal Lithium Battery Recharge

The internal lithium battery sustains the operation of the clock. When the Date/Time Indication becomes [--], the internal lithium battery is exhausted.



1 Connect the AC Adaptor to the Camera Recorder with the power turned off and then connect to the AC Mains socket.

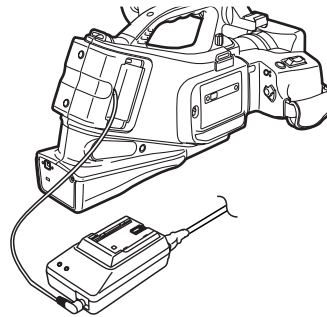

- After charging for 4 hours, the built-in lithium battery can power the clock for approximately 3 months.

LP Mode

A desired recording speed can be selected with [REC SPEED] on the [RECORDING SETUP] Sub-Menu.

If LP Mode is selected, the recording time becomes 1.5 times longer than that of SP Mode.

Although the image quality does not decrease with the LP Mode recording, mosaic-pattern noise may appear on a playback image, or some normal functions may be restricted.

- The contents that are recorded in LP Mode are not completely compatible with other equipment.
- Audio dubbing is not possible with LP Mode. (-38-)

Audio Recording Mode

The sound quality of the recorded sound can be selected with [AUDIO REC] on the [RECORDING SETUP] Sub-Menu.

High sound-quality recording is possible with "16 bit 48 kHz 2 track" Mode. With the "12 bit 32 kHz 4 track" Mode, the original sound can be recorded on 2 tracks in stereo, while the other 2 tracks can be used for Audio Dubbing.

Holding the Camera Recorder for Recording

Normal Recording.



- When walking while recording, keep both eyes open so that you can see where you are going and what is happening around you.
- Place the Camera Recorder on your right shoulder and hold it firmly with both hands.
- Hold the Eyecup of the Viewfinder as close as possible to your right eye.
- Take a firm stance with the legs slightly apart.
- For stable images, it is recommended to use a tripod (optional) whenever possible.

For More Stable Pictures.



- Stabilize the Camera Recorder by resting your elbows on a table or other stable horizontal surface.

Low-Angle Recording.



Adjust the angle of the LCD Monitor according to the position in which the Camera Recorder is held.

- If the Camera Recorder is not held firmly in stable position, the picture in the LCD Monitor cannot be watched properly.
- For easier long-angle recording, the Sub Recording Start/Stop Button and the Sub Zoom Lever on the front of the Camera Recorder can be used.

Recording from a high position.



Recording

When recording with the [AUTO/MANUAL/PROG.AE] Switch 15 set to [AUTO], the Camera Recorder automatically adjust the focus and white balance. In some cases, they cannot be adjusted automatically and need to be adjusted manually. (-27-, -29-)

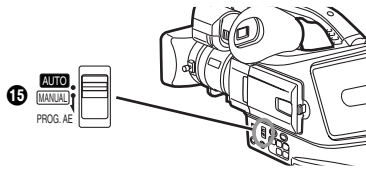

1 Set the [OFF/ON] Switch 50 to [ON].

- The [CAMERA] Lamp 48 lights up.

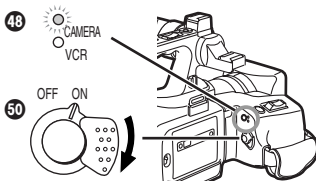

2 Press the Recording Start/Stop Button 49 (or Sub Recording Start/Stop Button 34).

- Recording starts.
- After the [RECORD] is displayed, it changes to [REC].

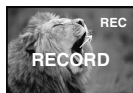
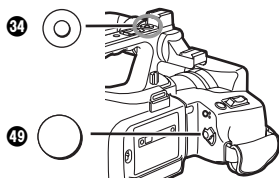

■ Recording Lamp (Tally Lamp)

The Recording Lamp 2 lights up during recording and alerts those being recorded that recording is in progress.

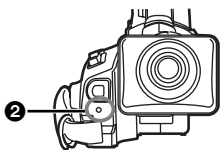

- The Recording Lamp does not light up if the [REC LAMP] on the [OTHER FUNCTIONS] Sub-Menu is set to [OFF].

■ To Pause the Recording

Press the Recording Start/Stop Button 49 (or 34) again.

The [PAUSE] Indication is displayed.



- If the Recording Pause Mode continues for more than 5 minutes, the power is turned off automatically for tape protection and power conservation. To resume recording from this condition, turn off, then turn on the power again.

■ To Check the Recording

By pressing the Recording Check Button [SEARCH] 20 briefly in the Recording Pause Mode, you can play back the last few seconds of the recorded scene.

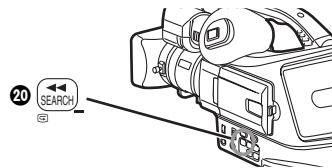

- The [CHK] Indication is displayed. After checking, the Camera Recorder resumes the Recording Pause Mode.

■ To View the Recorded Scene while the Recording is Paused (Camera Search)

The recorded scene can be viewed by keep pressing the [SEARCH -] Button 20 or [SEARCH +] Button 23 in the Recording Pause Mode.

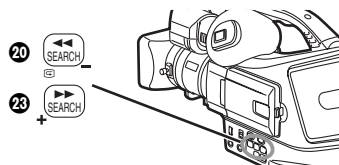

- When the [SEARCH -] Button is pressed, images are played back in the reverse direction.
- When the [SEARCH +] Button is pressed, images are played back in the forward direction.

Recording

■ Recording Yourself

By opening the LCD Monitor and rotating it frontward (to the lens side), you can let the subject in front of the Camera Recorder monitor the shot while recording is in progress.

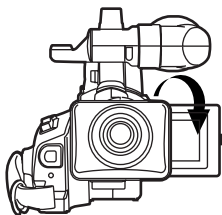

- When the LCD Monitor is opened, the Viewfinder is disabled automatically. However, when the LCD Monitor is rotated frontward, the image is also shown in the Viewfinder.
- If you prefer to have the image on the LCD Monitor to look like an image in a mirror, set [SELF REC] on the [OTHER FUNCTIONS] Sub-Menu to [MIRROR]. Images are recorded normally and no left and right reversal occurs.
- If [MIRROR] is used during self-recording, only the basic indications, such as the Recording Indication [●], Recording Pause Indication [●||] and Remaining Battery Power Indication [▣], are displayed.
- If a general Warning/Alarm Indication [!] appears, return the LCD Monitor to the original position in order to check the specific content of the Warning/Alarm Indication.

■ To Finish the Recording

Set the [OFF/ON] Switch  to [OFF].

- For other notes concerning this item, see -42-.

Photoshot

This Camera Recorder can take approximately 7 seconds still pictures containing sound.

I Press the [PHOTO SHOT] Button 29 in the Recording Pause Mode.

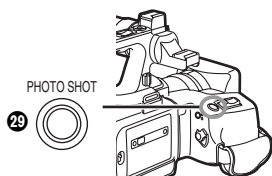

- The Camera Recorder records a still picture for about 7 seconds and then switches back to the Recording Pause Mode.

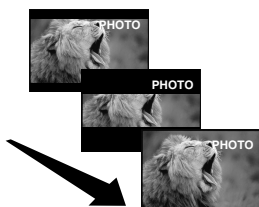

■ Progressive Photoshot

With the Progressive Photoshot Function, you can record still pictures with higher resolution than with the normal Photoshot Function.

- When [PROGRESSIVE] on the [CAMERA SETUP] Sub-Menu is set to [AUTO], the [P] Indication is displayed. When the [P] Indication is displayed, press the [PHOTO SHOT] Button in the Recording Pause Mode.



- This function may not work with some function setups. (-64-)

■ Continuous Photoshot

If you set [SHTR EFFECT] on the [OTHER FUNCTIONS] Sub-Menu to [ON] and keep the [PHOTO SHOT] Button pressed, the Camera Recorder will continuously record still pictures in approximately 0.7 seconds intervals until the button is released. (However, this does not operate when using Progressive Photoshot.)

- The screen blinks and, at the same time, a shutter clicking sound is recorded.

■ Digital Still Picture

When the [STILL] Button 24 is pressed, images become still pictures. When the button is pressed again, the Digital Still Picture Mode is cancelled.

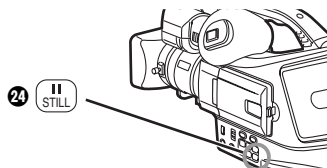

- We recommend that you press the [STILL] Button first at the position where you wish to record the picture so as to enter the Digital Still Picture Mode and then press the [PHOTO SHOT] Button.
- For other notes concerning this item, see -42-, -43-.

Zoom In/Out Functions

It gives special effects to the video by recording objects close by or with wide-angle shot.

1 For wide-angle shots (zoom out):

Push the [W/T] Lever **30** (or Sub Zoom Lever **33**) towards [W].

For close-ups (zoom in):

Push the [W/T] Lever towards [T].

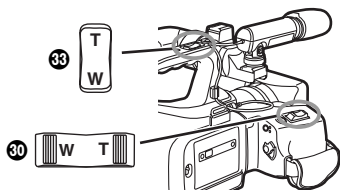

- Zoom Magnification Indication is displayed for a few seconds.



■ To Take Close-up Shots of Small Subjects (Macro Close-up Function)

(Macro Close-up Function)

When the zoom magnification is 1×, the Camera Recorder can focus on a subject that is as close as approximately 20 mm from the Lens. With this, small subjects like insects can be recorded.

■ To Use the Zoom Microphone Function

Along with the zooming operation, the microphone's directional angle and sensitivity are varied for recording sounds.

- Set [CAMERA FUNCTIONS] >> [RECORDING SETUP] >> [ZOOM MIC] >> [ON].
- The [Z.MIC] Indication appears. (The Indication is for the built-in microphone.)



- For other notes concerning this item, see -43-.

Digital Zoom Function

This function is useful when you want to record close-up shots of subjects located beyond a normal zoom range of 1× to 15× magnification. With the Digital Zoom Function, you can select a magnification of 30× or even to 750×.

1 Set [CAMERA FUNCTIONS] >> [CAMERA SETUP] >> [D.ZOOM] >> [30×] or [750×].

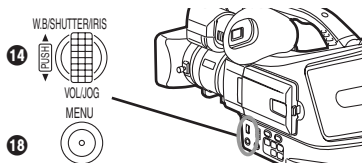

- 30×: Digital zooming to 30×
- 750×: Digital zooming to 750×

2 Press the [DIG.E.] Button **16** until the [D.ZOOM] Indication appears.

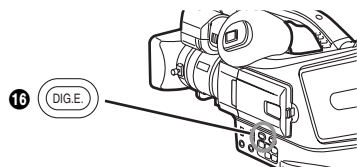

- When you press the [DIG.E.] Button, the Indications change in following order.
[AUTO EIS] → [AUTO EIS] + [D.ZOOM] → [D.ZOOM] → no Indication → [AUTO EIS]...

3 Push the [W/T] Lever **30** (or **33**) towards [W] or towards [T] to zoom in or out.

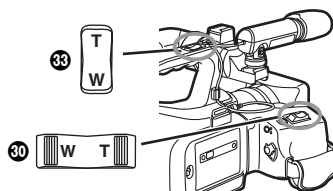

To Cancel the Digital Zoom Function

Press the [DIG.E.] Button **16** until the [D.ZOOM] Indication disappears.

- For other notes concerning this item, see -43-.

Image Stabilizer Function

If the Camera Recorder might be shaken while recording, the camera shake in the image can be corrected.

- If the Camera Recorder shakes too much, this function may not be able to stabilize images.

1 Press the [DIG.E.] Button **16** until the [AUTO EIS] Indication appears.

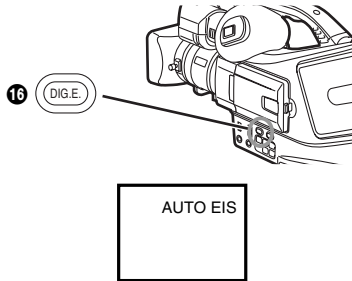

To Cancel Image Stabilizer

Press the [DIG.E.] Button **16** until the [AUTO EIS] Indication disappears.

- For other notes concerning this item, see -43-.

Fade In/Out Functions

Fade In

Fade In brings out images and sounds gradually from a black screen at the beginning of a scene.



1 Keep pressing the [FADE] Button **21** during the Recording Pause Mode.

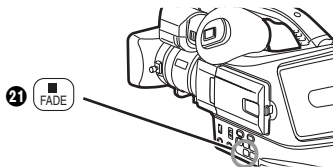

- The image fades out gradually.

2 When the image is completely gone, press the Recording Start/Stop Button **49** to start recording.

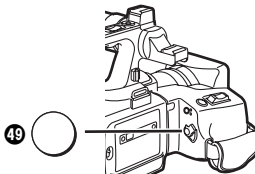

3 Release the [FADE] Button **21** about 3 seconds after starting recording.

- The image reappears gradually.

Fade Out

Fade Out causes images and sounds to disappear gradually, leaving a black screen at the end of a scene.

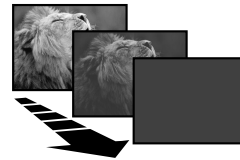

1 Keep pressing the [FADE] Button **21** while recording.

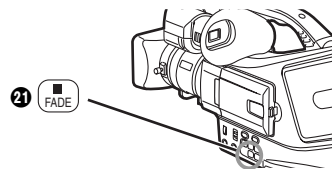

- The image fades out gradually.

2 When the image is completely gone, press the Recording Start/Stop Button **49** to stop recording.

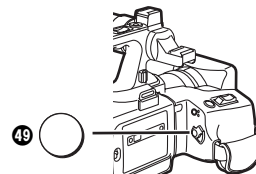

3 Release the [FADE] Button **21**.

- The still picture cannot fade in or fade out.

Backlight Compensation Function

This prevents a recording subject from being recorded darker in backlight. (Backlight is the light that shines from behind a recording subject.)

I Press the [BLC] Button 22.

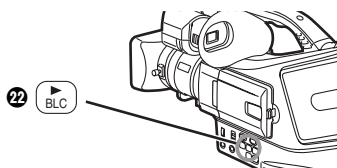

- The [] Indication flashes and then is displayed.
- The entire screen becomes brighter.



To Resume Normal Recording

Press the [BLC] Button.

- For other notes concerning this item, see -43-.

Wind Noise Reduction Function

This function reduces the sound of a wind hitting the microphone when recording.

I Set [CAMERA FUNCTIONS] >> [RECORDING SETUP] >> [WIND CUT] >> [ON].

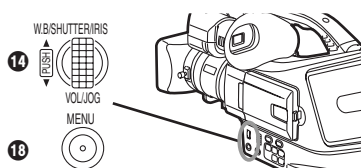

- The [WIND CUT] Indication appears. (The Indication is for the built-in microphone.)



To Cancel the Wind Noise Reduction Function

Set [CAMERA FUNCTIONS] >> [RECORDING SETUP] >> [WIND CUT] >> [OFF].

- For other notes concerning this item, see -43-.

Cinema Function

This function is for recording in a cinema-like wide screen.

I Set [CAMERA FUNCTIONS] >> [CAMERA SETUP] >> [CINEMA] >> [ON].

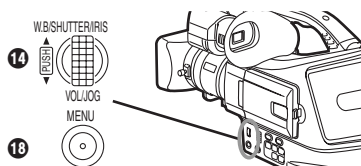

- Black bars appear at the top and bottom of the screen.



To Cancel the Cinema Mode

Set [CAMERA FUNCTIONS] >> [CAMERA SETUP] >> [CINEMA] >> [OFF].

- For other notes concerning this item, see -43-.

Recording in Special Situations

(Program AE)

You can select optimal automatic exposures under specific recording situations.

1 Repeatedly slide the [AUTO/MANUAL/PROG.AE] Switch 15 downwards from the [MANUAL] position until a desired mode [Sports], [Portrait], [Low Light], [Spotlight] or [Surf & Snow] appears.

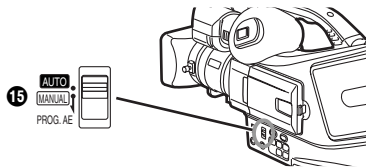

- The Indication of the selected Mode appears.

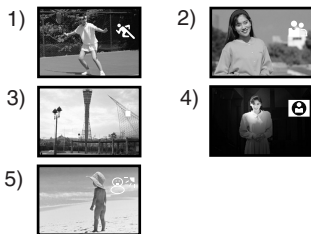

1) [Sports] Sports Mode

- For recording scenes involving quick movements, such as sports scenes.

2) [Portrait] Portrait Mode

- For bringing up people clearly from the background.

3) [Low Light] Low Light Mode

- For recording a dark scene brighter.

4) [Spotlight] Spotlight Mode

- For recording a subject under spotlight in a party, theatre, etc.

5) [Surf & Snow] Surf & Snow Mode

- For recording in a glaring surrounding, such as skiing grounds, beaches, etc.

To Cancel the Program AE Function

Set the [AUTO/MANUAL/PROG.AE] Switch to [AUTO].

- For other notes concerning this item, see -43-.

Recording in Natural Colors

(White Balance)

Depending on the scene or light condition, the Automatic White Balance Adjustment Mode may not be able to bring out natural colors. In such a case, the white balance can be adjusted manually.

When the Camera Recorder is turned on with the Lens Cap on, the Automatic White Balance Adjustment may not function properly. Please turn on the Camera Recorder after removing the Lens Cap.

1 Set the [AUTO/MANUAL/PROG.AE] Switch 15 to [MANUAL].

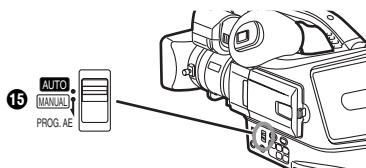

- The [MNL] Indication appears.

2 Press the [PUSH] Dial 14.

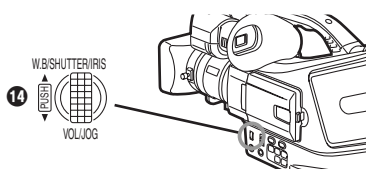

- The [AWB] Indication appears.

3 Turn the [PUSH] Dial 14 to set a desired White Balance Mode.

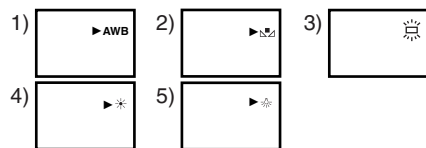

- 1) Automatic White Balance Adjustment [AWB]
- 2) The white balance setting that was previously set manually [Manual]
- 3) Fluorescent Lamp Mode [Fluorescent Lamp Mode]
- 4) Outdoor Mode [Outdoor Mode]
- 5) Indoor Mode (recording under incandescent lamp) [Indoor Mode]

To Resume Automatic Adjustment

Turn the [PUSH] Dial until the [AWB] Indication appears. Or, set the [AUTO/MANUAL/PROG.AE] Switch to [AUTO].

Adjusting White Balance Manually

White Balance Adjustment recognizes the color of light and makes adjustment so that the white color will become pure white. The Camera Recorder determines the hue of light that it receives through the Lens and White Balance Sensor, thereby judging the recording condition, and selects the closest hue setting. This function is called Automatic White Balance Adjustment.

For light outside the functional Auto White Balance Adjustment range, use the Manual White Balance Adjustment Mode.

1 Attach the Lens Cap and zoom in until the entire screen becomes white.

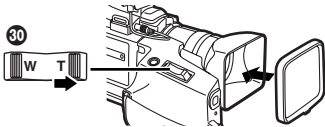

2 Set the [AUTO/MANUAL/PROG.AE] Switch 15 to [MANUAL].

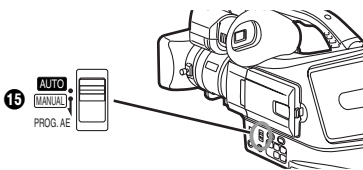

- The [MNL] Indication appears.

3 Press the [PUSH] Dial 14.

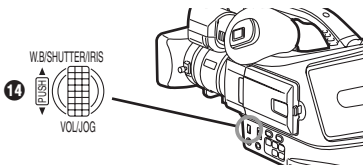

- The [AWB] Indication appears.

4 Turn the [PUSH] Dial 14 until the [MNL] Indication is displayed.



5 Keep pressing [PUSH] Dial 14 until the [MNL] Indication stops flashing.

To Resume Automatic Adjustment

Turn the [PUSH] Dial until the [AWB] Indication is displayed. Or, set the [AUTO/MANUAL/PROG.AE] Switch to [AUTO].

About White Balance Sensor

The White Balance Sensor 1 determines the nature of the light source during recording.

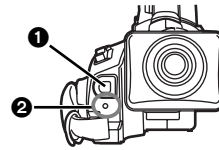

- Do not cover the White Balance Sensor with your hand during recording. Otherwise, White Balance will not function normally.
- The red light from the Recording Lamp 2 will be reflected off your hand or object, possibly causing the White Balance sensor to operate incorrectly and changing the coloring.

Outside of the effective range of Automatic White Balance Adjustment, the image will become reddish or bluish. Even within the effective range of Automatic White Balance Adjustment, the Automatic White Balance Adjustment may not function properly if there is more than one light source. In this case, adjust the White Balance.

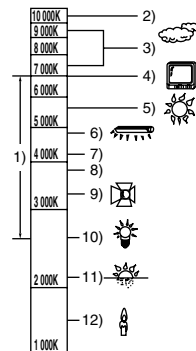

- 1) The effective range of Automatic White Balance Adjustment on this Camera Recorder
- 2) Blue sky
- 3) Cloudy sky (Rain)
- 4) TV screen
- 5) Sunlight
- 6) White fluorescent lamp
- 7) 2 hours after sunrise or before sunset
- 8) 1 hour after sunrise or before sunset
- 9) Halogen light bulb
- 10) Incandescent light bulb
- 11) Sunrise or sunset
- 12) Candlelight

- For other notes concerning this item, see -44-.

Manual Shutter Speed Adjustment

It is useful for recording fast-moving subjects.

- 1 Set the [AUTO/MANUAL/PROG.AE] Switch 15 to [MANUAL].

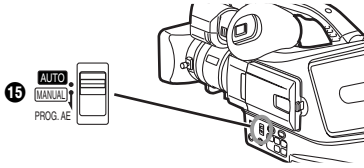

- The [MNL] Indication appears.

- 2 Press the [PUSH] Dial 14 until the Shutter Speed Indication appears.

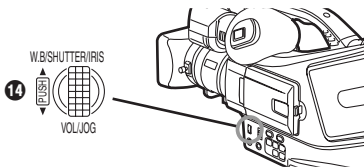

- 3 Turn the [PUSH] Dial 14 to adjust the shutter speed.

Range of Shutter Speed Adjustment

1/60–1/8000 s

The standard shutter speed is 1/60 s.

Selecting a speed closer to [1/8000] causes the shutter speed to be faster.

To Resume Automatic Adjustment

Set the [AUTO/MANUAL/PROG.AE] Switch to [AUTO].

- For other notes concerning this item, see -44-.

Manual Iris Adjustment

(F Number)

You can use this function when the screen is too bright or too dark.

- 1 Set the [AUTO/MANUAL/PROG.AE] Switch 15 to [MANUAL].

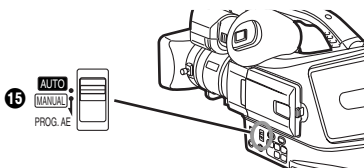

- The [MNL] Indication appears.

- 2 Press the [PUSH] Dial 14 until the Iris Indication appears.

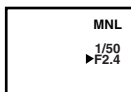
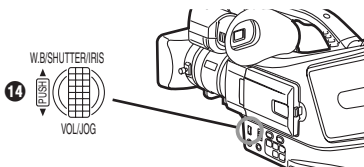

- 3 Turn the [PUSH] Dial 14 to adjust the iris.

Range of Iris Adjustment

CLOSE (Closed), F16, ..., F2.0,

OP (Opened)+0dB, ..., OP+18dB

When the Gain-up Mode [GAIN-UP] (-29-) is used, Iris adjustment is by OP+15dB.

When a value closer to [CLOSE] is selected, the image becomes darker.

When a value closer to [OP+18dB] is selected, the image becomes brighter.

The value to which +dB is attached indicates a Gain-up value. If this value is too large, the quality of the image deteriorates.

To Resume Automatic Adjustment

Set the [AUTO/MANUAL/PROG.AE] Switch to [AUTO].

- For other notes concerning this item, see -44-.

Manual Focus Adjustment

Focus can be adjusted manually for recording in a situation where auto focus may not function well.

1 Set the [AUTO/MANUAL/PROG.AE] Switch ⑮ to [MANUAL].

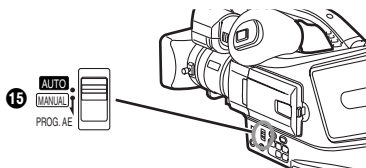

- The [MNL] Indication appears.

2 Press the [FOCUS] Button ⑰.

- The [▶MF] Indication (Manual Focus Mode) appears.

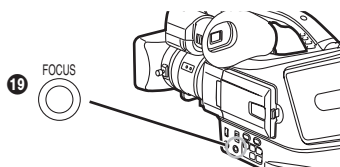

3 Turn the Focus Ring ⑦ to adjust the focus.

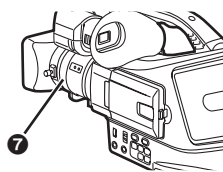

In the following cases, the Focus Ring cannot be used.

- When the Menu Screen is displayed.
- When you are adjusting the White Balance shutter speed or Iris.

To Resume Automatic Adjustment

Set the [AUTO/MANUAL/PROG.AE] Switch to [AUTO] or press the [FOCUS] Button.

Picture Effect Functions

This Camera Recorder is equipped with Picture Effect Functions that add special effects to the scene.

Picture Effects (With [PIC.E.] Button)



- 1) Wipe Mode [WIPE]
- 2) Mix Mode [MIX]
- 3) Strobe Mode [STROBE]
 - It records images with a stroboscopic effect.
- 4) Gain-up Mode [GAIN-UP]
 - It brightens images electronically.
 - Adjust focus manually when using this mode.
(-29-)
- 5) Trailing Effect Mode [TRAIL]
 - It records images with a trailing effect.
- 6) Mosaic Mode [MOSAIC]
 - It produces a mosaic-like image.
- 7) Mirror Mode [MIRROR]
 - The right half of an image becomes a mirror image of the left half.

To Select a Desired Picture Effect

1 Press the [PIC.E.] Button ⑰ until a desired effect appears.

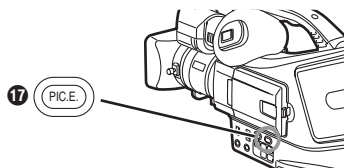

To Cancel the Picture Effect

Press the [PIC.E.] Button ⑰ until the Picture effect disappeared.

Picture Effect Functions

Picture Effects (From [P.EFFECT] Menu)



- 1) Negative Mode [NEGA]
 - The colors of the recorded image are inverted as seen in a negative.
- 2) Sepia Mode [SEPIA]
 - It records a scene with a brownish tint, like the color of old pictures.
- 3) Monotone Mode [MONO]
 - It records a monotone image.
- 4) Solarisation Mode [SOLARI]
 - It records an image with a painting-like effect.

To Select a Desired Picture Effect

- 1 Set [CAMERA FUNCTIONS] >> [CAMERA SETUP] >> [P.EFFECT] >> a desired Picture Effect.

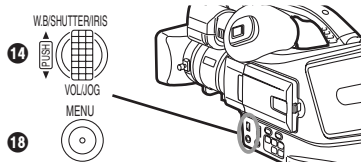

- If the Camera Recorder is turned off, this setting is cancelled.

To Cancel the Picture Effect

- Set [CAMERA FUNCTIONS] >> [CAMERA SETUP] >> [P.EFFECT] >> [OFF].

- For other notes concerning this item, see -44-.

Wipe Mode and Mix Mode

Wipe Mode:

Like a curtain is being pulled, the still picture of the last recorded scene gradually changes to the moving image of a new scene.

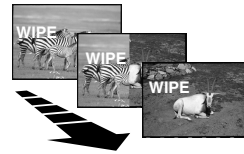

Mix Mode:

While the moving image of a new scene fades in, the still image of the last recorded scene gradually fades out.

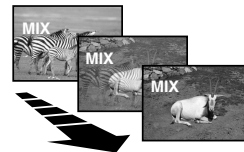

- 1 Press the [PIC.E.] Button 17 until the [WIPE] or [MIX] Indication is displayed.

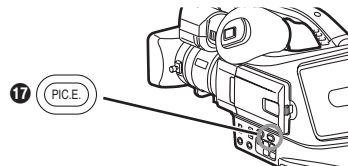

- The [WIPE] or [MIX] Indication appears.

- 2 Press the Recording Start/Stop Button 49 to start recording.

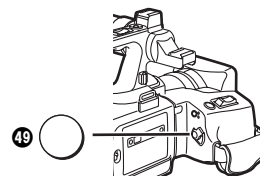

- 3 Press the Recording Start/Stop Button 49 to pause the recording.
 - The last scene is stored in memory. The [WIPE] or [MIX] Indication changes to [WIPE] or [MIX].

- 4 Press the Recording Start/Stop Button 49 to restart the recording.
 - The last image of the previous scene gradually changes to the new scene.

- For other notes concerning this item, see -44-.

Adjusting the Microphone Sensitivity Level

You can adjust the microphone sensitivity for recording.

1 Set [CAMERA FUNCTIONS] >> [RECORDING SETUP] >> [MIC LEVEL ADJ.] >> [YES].

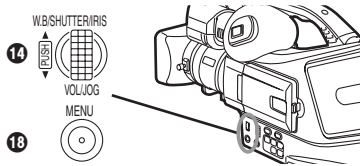

- The [MIC LEVEL SETUP] Menu appears.

2 Press the [PUSH] Dial (14) to select the [MNL (AGC*, NO-AGC)].

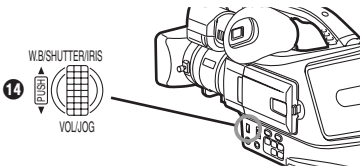

- The Microphone Level Meter appears.

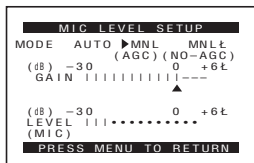

- AGC* : Auto Gain Control

AUTO:

AGC is activated, and the recording level is adjusted automatically. The Microphone Level Meter does not appear.

MNL (AGC):

The desired recording level can be set. AGC will also be activated to reduce the amount of distortion in the music.

MNL (NO-AGC):

AGC is not activated and so natural recording can be performed. Adjust in such a way that the sound will not be distorted at the maximum volume level.

3 Turn the [PUSH] Dial (14) to increase or decrease the bars of the [GAIN] Indication.

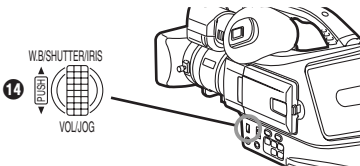

- Adjust the [GAIN] value so that the last 3 Bars of the [LEVEL (MIC)] will not light red. (Otherwise, the Sound is distorted.)
- For other notes concerning this item, see -44-.

Playing Back

The recorded scene can be played back immediately after the recording.

1 Set the [OFF/ON] Switch 50 to [ON].

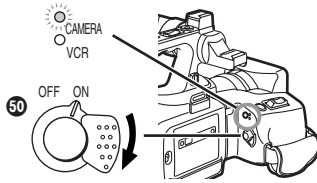

2 Press the [MODE] Button 47.

- The [VCR] Lamp 48 lights up.

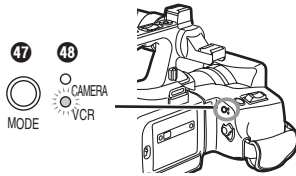

3 Press the [◀◀] Button 20 to rewind the tape.

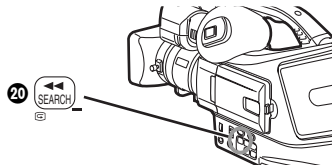

- Rewind the tape to the point where you want to start playback.
- When the tape reaches the beginning, rewinding stops automatically.

4 Press the [▶] Button 22 to start playback.

- The [▶] Indication appears.

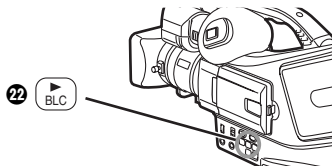

To Stop Playback

Press the [■] Button 21.

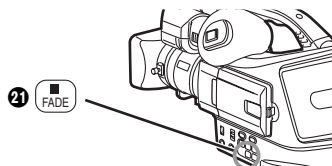

■ Adjusting the Sound Volume

Until the [VOLUME] Indication appears, keep pressing the [PUSH] Dial 14. Then, turn the [PUSH] Dial to adjust the volume. After the adjustment, press the [PUSH] Dial to make the [VOLUME] Indication disappear.

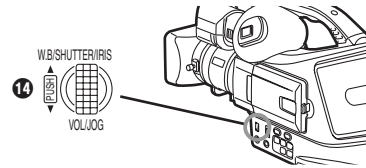

To adjust the volume with the Remote Controller, press the [T] or [W] Button to display the [VOLUME] Indication. Press the [T] Button to increase the volume or press the [W] Button to decrease the volume. The [VOLUME] Indication goes off a few seconds after the adjustment is finished.



- The sound volume cannot be adjusted using the Remote Controller in Playback Zoom Function. (-36-)
- If a cassette recorded with a copyright protection signal is played back, the picture is distorted by mosaic-like patterns.
- For other notes concerning this item, see -44-.

Finding a Scene You Want to Play Back

■ Cue/Review Playback

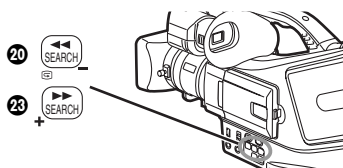

If the [▶▶] Button 23 or [◀◀] Button 20 is pressed during Playback, it turns to Cue Playback (A) or Review Playback (B).

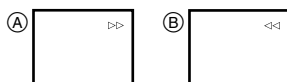

- If the Button is held continuously, it turns to Cue Playback or Review Playback until you release it.

■ Variable Speed Search Function

The speed of Cue Playback or Review Playback can be varied.

1 During playback, press the [▶] Button 22.

- The [1×▶] Indication appears.

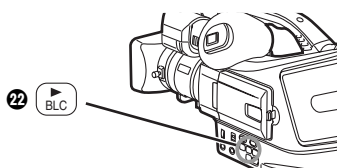

2 Turn the [PUSH] Dial 14 to select a desired search speed.

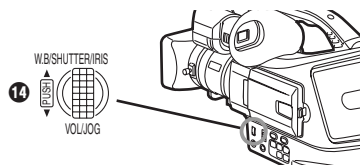

The following 6 playback speeds are available for the Variable Speed Search Function in both the fast-forwarding and rewinding directions: 1/5× (slow playback in SP Mode only), 1/3× (slow playback in LP Mode only), 1×, 2×, 5×, 10× and 20×.

- On the Remote Controller this function can be done by pressing the [VAR.SEARCH] and cursor buttons ([▲], [▼]).

To Resume Normal Playback

Press the [▶] Button 22.

- During Cue or Review Playback, fast-moving images may show mosaic-pattern noise.
- The sound is muted during search even in the [× 1▶] speed mode.

Slow Motion Playback

This Camera Recorder can play back at a slow speed.

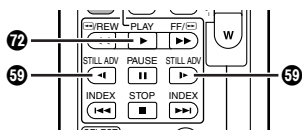

1 Press the [▶] Button 72.

2 Press the [◀] Button or [▶] Button 59 on the Remote Controller.

- The [■▶] or [◀■] Indication appears.



- When the [◀] Button is pressed, Slow Motion Playback proceeds in the reverse direction. When the [▶] Button is pressed, Slow Motion Playback proceeds in the forward direction.

Scenes recorded in the SP Mode are played back at approximately 1/5th of the normal speed.

Scenes recorded in the LP Mode are played back at approximately 1/3rd of the normal speed.

To Resume Normal Playback

Press the [▶] Button 72.

Still Playback/Still Advance Playback

This Camera Recorder is capable of still picture playback and frame-advance playback.

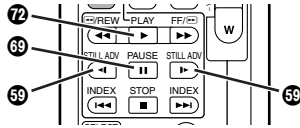

1 Press the [▶] Button 72.

2 Press the [⏸] Button 69.

- The playback image stops in the Still Playback Mode.

3 Press the [◀] Button or [▶] Button 59 on the Remote Controller.

- With each pressing of the [◀] Button, still pictures advance in the reverse direction. With each pressing of the [▶] Button, still pictures advance in the forward direction. If either one of the buttons continues to be pressed, still pictures advance continuously 1 frame at a time until the button is released.

To Resume Normal Playback

Press the [▶] Button 72.

Jog Playback

By turning the Jog Dial ([PUSH] Dial) 14 of the Camera Recorder in the Still Playback Mode, still pictures can be advanced one frame at a time in the forward or backward direction.

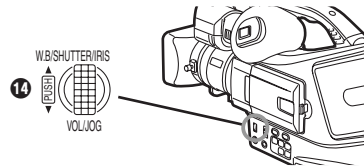

- If the Camera Recorder is left in the Still Playback Mode for more than 5 minutes, the Camera Recorder switches to the Stop Mode to protect the video heads from excessive wear and tear.

Finding the End of Recording

(Blank Search Function)

The Blank Search Function aids you locate the end of the recording on the Cassette quickly.

1 Set [VCR FUNCTIONS] >> [PLAYBACK FUNCTIONS] >> [BLANK SEARCH] >> [YES].

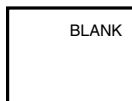
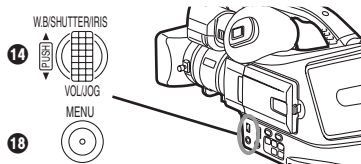

- The [BLANK] Indication appears during the Blank Search.
- Approximately 1 second before the last recorded scene, the Camera Recorder switches to the Still Playback Mode.
- If there is no blank portion left on the Cassette, the Camera Recorder stops at the end of the tape.

To Cancel Blank Search Before Completion

Press the [■] Button.

Index Search Functions

To facilitate searching of desired scene, this Camera Recorder automatically records index signals during recording, as explained in the following.

Photoshot Index Signal

These signals are automatically recorded whenever still pictures are taken in Photoshot Mode. (-22-) Photoshot Index Signals are not recorded on still pictures recorded in Continuous Photoshot Mode.

Scene Index Signal

Scene Index Signals are automatically recorded when you start recording after inserting a Cassette.

- If [SCENEINDEX] of [RECORDING SETUP] Sub-Menu on the [CAMERA FUNCTIONS] Main-Menu is set to [2HOUR], an index signal is recorded when recording is restarted after an elapse of 2 hours or longer. If it is set to [DAY], an index signal is recorded when recording is restarted after the date has changed since the last recording. (While the index signal is recorded, the [INDEX] Indication flashes for a few seconds.)



- If the Camera Recorder is switched from the VCR Mode to Camera Mode or if the date and time is set before the start of recording, the index signal is not recorded.

Photoshot Index Search

- 1 Set [VCR FUNCTIONS] >> [PLAYBACK FUNCTIONS] >> [SEARCH] >> [PHOTO].

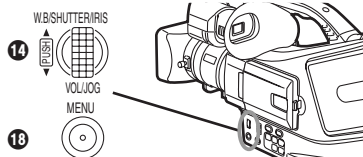

- 2 Press the [MENU] Button 18.

- 3 Press the [▶▶] Button or [◀◀] Button 60 on the Remote Controller.

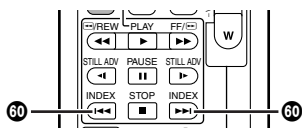

- With each press of the corresponding button, still pictures recorded in Photoshot Mode are searched.
- Sounds are played back for approximately 4 seconds.

Scene Index Search

- 1 Set [VCR FUNCTIONS] >> [PLAYBACK FUNCTIONS] >> [SEARCH] >> [SCENE].

- 2 Press the [MENU] Button 18.

- 3 Press the [▶▶] Button or [◀◀] Button 60 on the Remote Controller.

- When the corresponding button is pressed once, the [S 1] Indication appears, and searching of the subsequent scene marked with an index signal starts. Each time the button is pressed after the start of Scene Index Search, the indication changes from [S 2] to [S 9], and the beginning of the scene corresponding to the selected number will be searched.

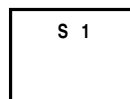

- Up to 9 scene numbers can be selected.

Continuous Index Search

If the [▶▶] Button or the [◀◀] Button 60 is pressed for 2 seconds or longer, search can be continued at several-second intervals. (To cancel, press the [▶] Button 72 or the [■] Button 70.)

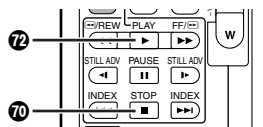

- For other notes concerning this item, see -44-.

Playback Zoom Function

A part of the image can be enlarged up to 10 times during playback.

1 During playback, press the [P.B. ZOOM] Button 66 on the Remote Controller.

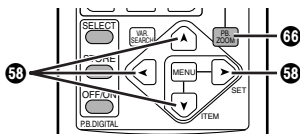

- The center of the image is enlarged to approximately 2 times.



2 Change the magnification by pressing the [W] Button or [T] Button 64 on the Remote Controller.

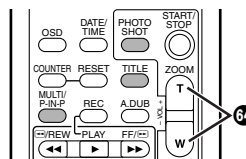

3 Press the Arrow Button (▲, ▼, ◀, ▶) 58 on the Remote Controller that points to the area you want to enlarge.

To Change the Enlarging Area of an Image
Press the [P.B. ZOOM] Button 66 on the Remote Controller.

- For other notes concerning this item, see -45-.

Playback Digital Effect Functions

During playback, special digital effects can be added to the recorded pictures. The same effects as those of Picture Effects, which are used during recording, are obtained.

1 Press the [▶] Button 72.

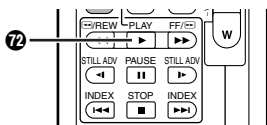

2 Press the [SELECT] Button 61 on the Remote Controller to select a desired digital effect.

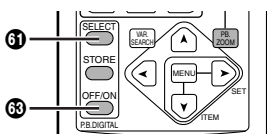

- When the [SELECT] Button is pressed repeatedly, the digital effect selection changes.
- The same setting can be done using [DIGITAL EFFECT] Sub-Menu on the [VCR FUNCTIONS] Main-Menu.

To suspend Playback Digital Effect Temporarily

Press the [OFF/ON] Button 63 to suspend or restart the digital effect. When the digital effect is paused temporarily, the selected effect's indication flashes.

To Cancel the Digital Effect

Press the [SELECT] Button 61 on the Remote Controller and clear the digital effect indication.

Wipe Mode and Mix Mode

1 Press the [▶] Button 72.

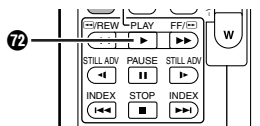

2 Press the [SELECT] Button 61 on the Remote Controller and select [WIPE] or [MIX].

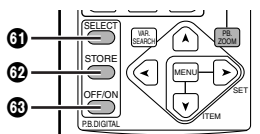

3 Press the [STORE] Button 62 at the moment you want to save as a still picture.

- The [WIPE] or [MIX] Indication appears, and the image is saved.

4 Press the [OFF/ON] Button 63 in the scene in which you want to use the Wipe or Mix effect.

- The scene changes as a result of the Wipe or Mix effect.

- The Wipe Function and Mix Function can be used only from the Remote Controller during playback.
- If the [OFF/ON] Button 63 is pressed while Wipe or Mix is carried out, the effect will stop temporarily at that point. Pressing the [OFF/ON] Button 63 again will bring back the effect.
- For other notes concerning this item, see -45-.

Playing Back on Your TV

By connecting your Camera Recorder with your TV, the recorded scenes can be viewed on your TV screen.

- Before connecting them, turn off the power of both the Camera Recorder and TV.

After connecting the Camera Recorder and the TV as illustrated, start playback.

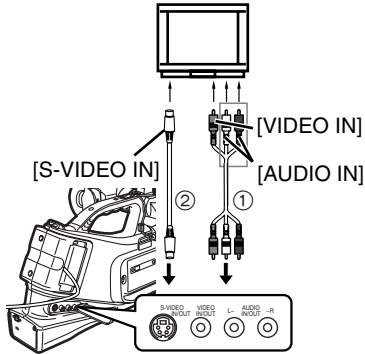

- Using the AV Cable ①, make a connection with the TV. If the TV has an S-Video Socket, connect the S-Video Cable ②, too.

To Make the Indications Appear on the TV Screen

Press the [OSD] Button 53 on the Remote Controller.

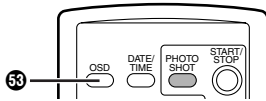

- For other notes concerning this item, see -45-.

Audio Dubbing

You can add music or narration to the recorded Cassette.

- If the tape recorded in the [16bit] Mode is dubbed with the Audio Dubbing function, the original sound is erased. (If you wish to preserve the original sound, use the [12bit] Mode when recording.)
- Audio Dubbing cannot be performed on a recording done in LP Mode. (-I8-)

1 Set [VCR FUNCTIONS] >> [AV IN/OUT SETUP] >> [AV JACK] >> [IN/OUT].

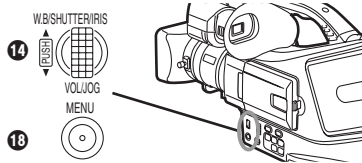

2 Continuing the aforesaid setup, select [A.DUB INPUT] >> [MIC] or [AV IN].

- Set to [AV IN] when external device is used, and to [MIC] when an external or built-in microphone is used.

3 Switch the Camera Recorder over to the Still Playback Mode where you want to add new sound.

4 Press the [A.DUB] Button 57 on the Remote Controller.

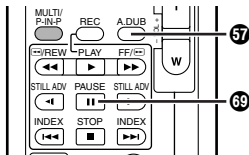

5 To start Audio Dubbing, press the [||] Button 69 on the Remote Controller.

To Cancel Audio Dubbing

Press the [||] Button 69 on the Remote Controller. The Camera Recorder is in the Still Playback Mode again.

To dub audio while listening to a pre-recorded sound

When pausing the audio dubbing, [12bit AUDIO] on the [PLAYBACK FUNCTIONS] Sub-Menu is automatically set to [ST2] and you can check the pre-recorded sound. When a microphone is used for audio dubbing, use headphones to listen to the pre-recorded sound while dubbing the audio. (When using headphones, set [AV JACK] on the [AV IN/OUT SETUP] Sub-Menu to [OUT].) When the line input is used, you can dub audio while listening to a pre-recorded sound from the speaker.

To Play Back the Sound Recorded by 12bit Audio Dubbing

Set [VCR FUNCTIONS] >> [PLAYBACK FUNCTIONS] >> [12bit AUDIO] >> [ST2] or [MIX].

ST1: It plays back only the original sound.

ST2: It plays back only the sound added by Audio Dubbing.

MIX: It plays back both the original sound and the sound added by Audio Dubbing simultaneously.

- For other notes concerning this item, see -45-.

To Adjust the Audio Level

You can adjust the Audio Level for Audio Dubbing.

1 Set [VCR FUNCTIONS] >> [RECORDING SETUP] >> [AUDIO LEVEL] >> [YES].

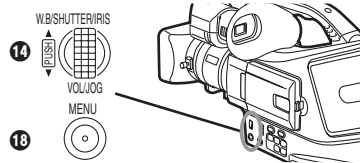

- The [AUDIO LEVEL SETUP] Menu appears.

2 Press the [PUSH] Dial 14 to select the [MNL (AGC, NO-AGC)].

- The Audio Level Meter appears.

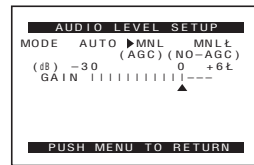

3 Turn the [PUSH] Dial 14 to increase or decrease the bars of the [GAIN] Indication.

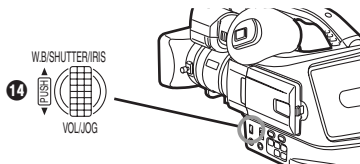

- For details, refer to the [MIC LEVEL ADJ.] on the [RECORDING SETUP] Sub-Menu of the [CAMERA FUNCTIONS] Main-Menu (-31-).

Copying on an S-VHS (or a VHS) Cassette

(Dubbing)

After connecting the Camera Recorder and the VCR as illustrated, start the following procedures.

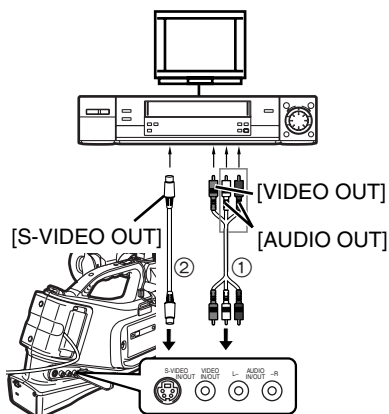

- ① AV Cable
 - ② S-Video Cable
- Be sure to press the [OSD] Button (-II-) on the Remote Controller prior to copying so that no indications are visible. Otherwise, the displayed tape counter and function indications are also copied.

Camera Recorder:

1 Insert the recorded Cassette.

VCR:

2 Insert an unrecorded Cassette with an erasure prevention tab.

- If various setups (such as external input, tape speed, etc.) are required, please refer to the operating instructions of your VCR.

Camera Recorder:

3 Press the [▶] Button to start playback.

VCR:

4 Start recording.

5 Press the Pause or Stop Button to stop recording.

Camera Recorder:

6 Press the [■] Button to stop playback.

Recording the Contents of Other Equipment

After connecting the Camera Recorder and the other equipment as illustrated, start the following procedures.

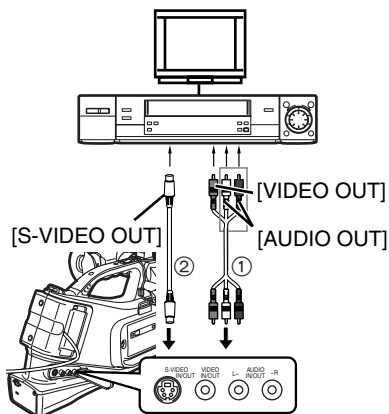

- ① AV Cable
- ② S-Video Cable

Camera Recorder:

1 Set [VCR FUNCTIONS] >> [AV IN/OUT SETUP] >> [AV JACK] >> [IN/OUT].

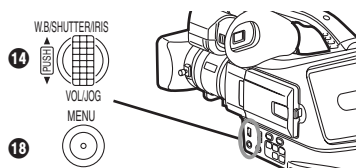

2 Insert an unrecorded Cassette.

Other Equipment:

3 Insert a recorded Cassette and start playback.

Camera Recorder:

4 While pressing the [REC] Button (56), press the [▶] Button (72).

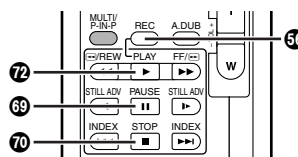

5 Press the [||] Button (69) or [■] Button (70) to stop recording.

Other Equipment:

6 Press the Stop Button to stop playback.

- For other notes concerning this item, see -45-.

Using the DV Cable for Recording

(Digital Dubbing)

By connecting this Camera Recorder with other digital video equipment that has a DV Input/Output Terminal using a DV Cable VW-CD1E (optional) ①, dubbing can be done in the digital format.

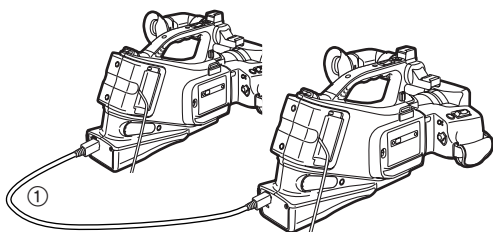

Player/Recorder:

1 Insert the Cassette and set to the VCR Mode.

Player:

2 Press the [▶] Button ⑦ to start playback.

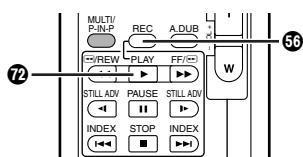

Recorder:

3 While pressing the [REC] Button ⑤, press the [▶] Button ⑦.

- Recording starts.

To Stop Dubbing



Press the [||] Button or the [■] Button.

- For other notes concerning this item, see -45-.

Indications

Various functions and the Camera Recorder status are shown on the screen.

: Remaining Battery Power

- When the battery power becomes low, the Indication changes. When the battery is discharged completely, the  () Indication flashes.

RO:45: Remaining Tape Time

- Remaining tape time is indicated in minutes. (When it reaches less than 3 minutes, the indication starts flashing.)

CINEMA: Cinema Mode -25-

D.ZOOM: Digital Zoom -23-

WIPE: Wipe Mode -29-

MIX: Mix Mode -29-

STROBE: Strobe Mode -29-

GAIN-UP: Gain-up Mode -29-

TRAIL: Trailing Effect Mode -29-

MOSAIC: Mosaic Mode -29-

MIRROR: Mirror Mode -29-

NEGA: Negative Mode -29-

SEPIA: Sepia Mode -29-

MONO: Monotone Mode -29-

SOLARI: Solarisation Mode -29-

ZOOM: Playback Zoom -36-

SP: Standard Mode (Recording Speed Mode) -18-

LP: Long Play Mode (Recording Speed Mode) -18-

INDEX: Index signal recording -35-

S 1: Search Number -35-

5×: Zoom Magnification Indication -23-

AUTO: Automatic Mode -20-

MNL: Manual Mode -26-, -27-

AUTO EIS: Image Stabilizer -23-

MIC, AV IN: Audio Dubbing Input Display -38-

12 bit, 16 bit: Audio Recording Mode -18-

MF: Manual Focus -29-

: Back Light Mode -25-

: Sports Mode (Program AE) -26-

: Portrait Mode (Program AE) -26-

: Low Light Mode (Program AE) -26-

: Spotlight Mode (Program AE) -26-

: Surf & Snow Mode (Program AE) -26-

REC: Recording -20-

PAUSE: Recording Pause -20-

: Playback -32-

: Forward Camera Search -20-

: Reverse Camera Search -20-

: Still Playback -34-

: Fast-forward/Cue Playback -32-

: Rewind/Review Playback -32-

: Slow Motion Playback -33-

: Still Advance Playback -34-

: Index Search -35-

CHK: Recording Check -20-

A.DUB : Audio Dubbing -38-

A.DUB : Audio Dubbing Pause -38-

PHOTO: Photoshot Mode Recording -22-

BLANK: Blank Search -34-

R : Repeat Playback -44-

2× : Variable Speed Search -34-

1/500: When you adjust shutter speed manually, this indication appears. -28-

F2.4: When you adjust the F Number manually, this indication appears. -28-

AWB: Automatic White Balance Mode -27-

: White Balance setting Mode -27-

: Fluorescent Lamp -27-

: Outdoor Mode -27-

: Indoor Mode (recording under incandescent lamp) -27-

Z.MIC: Zoom Microphone -23-

WIND CUT: Wind Noise Reduction -25-

: Progressive Photoshot Mode -22-

VOLUME: Volume adjustment -32-

10:30:45 AM Date/Time Indication -41-

■ To Change the Counter Display Mode

By changing [C.DISPLAY] on the [DISPLAY SETUP] Sub-Menu, you can change the Counter Display Mode to Tape Counter Indication [COUNTER] (0:00.00), Memory Counter Indication [MEMORY] (M0:00.00), and Time Code Indication [TIMECODE] (0h00m00s00f). (-18-) By repeatedly pressing the [COUNTER] Button on the Remote Controller, you can change the Counter Display Mode.

■ To Display Date/Time Indication

To display Date/Time Indication, set the appropriate Date/Time in [DATE/TIME] on the [DISPLAY SETUP] Sub-Menu. (-18-)

You can also press the [DATE/TIME] Button of the Remote Controller repeatedly to display or change the Date/Time Indication.

■ To Change the Display Mode

By changing [DISPLAY] on the [DISPLAY SETUP] Sub-Menu, you can change the Display Mode to All Function Display [ALL], Partial Display [PARTIAL] and Minimum Display [OFF].

Warning/Alarm Indications

If any one of the following indications lights up or flashes, please check the condition of the Camera Recorder.

BLANK: Blank Search -*34*-

DEW DETECT, EJECT TAPE:

Condensation has occurred. -*47*-

 CHECK REC TAB:

The accidental erasure prevention slider on the inserted Cassette is open (that is, set to [SAVE]).

You are about to do audio dubbing on the unrecorded (blank) portion of the tape.

No Cassette is inserted. -*14*-

: The Battery is low. Recharge it. -*12*-

: The video heads are dirty. -*47*-

 END: The tape came to end during recording.

CHECK REMOTE MODE:

Wrong Remote Controller Mode has been selected. -*11*-

INCOMPATIBLE DATA:

You are attempting to play back a tape section that has been recorded with a different TV system.

CANNOT REC LP-MODE:

Because the original recording was done in LP Mode, audio dubbing cannot be performed.

INCOMPATIBLE TAPE:

This Cassette is incompatible.

PUSH THE RESET BUTTON:

Mechanism Irregular is detected. Press the [RESET] Button (-*8*-). This may solve the problem.

NEED TO BE SERVICED:

It is a malfunction.

INCOMPATIBLE DATA:

Because the medium is protected by a copy guard, images cannot be recorded correctly.

Notes and Hints

■ Concerning the Power Supply

- When the Camera Recorder is used for a long time, the Camera body becomes warm, but this is not a malfunction.
- If the [CHARGE] Lamp does not light up although the Battery is attached to the AC Adapter, detach the Battery and reattach it.
- Battery CGP-D110 and CGP-D105 cannot be charged with this AC Adapter.

■ Inserting/Removing the Cassette

- In the case of using a previously recorded Cassette, you can use the Camera Search Function to find the position where you want to continue recording.
- If a new Cassette is inserted, rewind to the beginning of the tape before starting recording.
- When inserting the cassette, make sure it faces in the right direction and then push it in until it stops.

■ Alarm Sounds

When [BEEP SOUND] on the [OTHER FUNCTIONS] Sub-Menu on the [CAMERA FUNCTIONS] Main-Menu is set to [ON], confirmation/alarm beeps are issued as follows.

1 Beep

- When you start recording
- When you switch the [OFF/ON] Switch from [OFF] to [ON]

2 Beeps

- When you pause recording

2 Beeps ×4

- If you perform a wrong operation before or during recording

■ Recording

- Before turning on the power, remove the Lens Cap. If the Lens Cap is still attached when the power is turned [ON], Automatic White Balance Adjustment (-*27*-) may not function correctly.

■ Recording Check

- For Recording Check, the recording speed mode (SP/LP) must be the same as the mode used for the recording. If different, playback images will be distorted.

■ Camera Search

- In Camera Search Mode, images may contain mosaic-pattern noise. This is a phenomenon that is characteristic of digital video and not a malfunction.
- If the recording speed modes (SP/LP) of previous recording and new recording are different, playback images may be distorted.

■ Photoshot

- Photoshot Recording results in slightly inferior image quality.

Notes and Hints

■ Progressive Photoshot Function

- The still pictures are recorded at a slightly reworded point from where you press the [PHOTO SHOT] Button.
- When you change to the Still Picture Mode, you will hear a click. This is the sound of the iris closing and not an indication of malfunction.
- If you record still pictures in Progressive Photoshot Mode when your Camera Recorder is set to Program AE (-26-), the brightness of the images may change.
- The picture may be blurred when recording a scene with many horizontal lines or fine patterns.

About [PROGRESSIVE] Setup

- When the [P] Indication is displayed, you can use the Progressive Photoshot Function.

When [PROGRESSIVE] is set to [AUTO]

You cannot use the Progressive Photoshot Function in the following cases.

- When the zoom magnification is approximately 15× or higher
- When the shutter speed is 1/750 s or faster
- When Picture Effect is set to [WIPE], [MIX], [STROBE], [GAIN-UP], [TRAIL], [MOSAIC], [MIRROR]

■ Zoom In/Out Functions

- When you are zooming on a faraway subject, a sharper focus is achieved if the recording subject is 1.7 metres or more away from the Camera Recorder.
- The further you push the [W/T] Lever toward [W] or [T], the faster the zooming speed. But if you use the Sub Zoom Lever, the zooming speed cannot become faster.

■ Zoom Microphone Function

- It does not work with an external microphone.
- The Zoom Microphone Function may not work effectively if the surrounding noise is too loud.

■ Digital Zoom Functions

- As the magnification of digital zoom increases, the quality of image may deteriorate.
- White balance cannot be set in the digital zoom range.
- The further you push the [W/T] Lever toward [W] or [T], the faster the zooming speed. But if you use the Sub Zoom Lever, the zooming speed cannot become faster.

■ Image Stabilizer Function

- The Image Stabilizer Function does not operate in a dimly lit place. In this case, the [AUTO EIS] Indication flashes.
- Under fluorescent lighting, image brightness may change or colors may not look natural.
- After-images may appear.
- When a tripod is used, it is recommended that you turn off the Image Stabilizer.
- The Image Stabilizer Function does not operate when using the Gain-up Mode of Picture Effect Functions.

■ Backlight Compensation Function

- When setting the Iris manually, the Backlight Compensation Function does not work.
- By operating the [OFF/ON] Switch, the Backlight Compensation Function is cancelled.

■ Wind Noise Reduction Function

- It does not work with an external microphone.
- When it is set to [ON], directivity of microphone is regulated depending on the strength of wind to reduce wind noise.

■ Cinema Function

- Using the Cinema Mode does not widen the recording angle.
- If you play back tape recorded in Cinema Mode on a wide-screen (16:9) format TV, playback size is automatically adjusted to fit the TV screen format. Please refer to the TV's operating instructions for details.
- When images are displayed on a TV screen, the Date/Time Indication may be erased in some cases.
- Depending on the TV, the picture quality may be deteriorated.

■ Program AE

- If any of the Program AE Modes is selected, you cannot adjust the shutter speed (-28-) or iris (-28-).
- If the Picture Effect is set to [GAIN-UP], Sports, Portrait or Low-Light Mode is canceled.

Sports Mode

- During normal playback, the image movement may not look smooth.
- Because the color and brightness of the playback image may change, avoid recording under fluorescent light, mercury light or sodium light.
- If you record a subject illuminated with strong light or a highly reflective subject, vertical lines of light may appear.
- If the light is insufficient, the [] Indication flashes.

Sports Mode/Portrait Mode

- If you record a still picture in Progressive Photoshot Mode, the brightness and hue of the recorded still picture may become unstable.
- If this mode is used for indoor recording, playback images may flicker.

Low Light Mode

- Extremely dark scenes may not be able to be made brighter to a satisfactory degree.

Spotlight Mode

- With this mode, recorded images may turn out to be extremely dark.
- If the recording subject is extremely bright, its recorded image may turn out to be whitish.

Surf & Snow Mode

- If the recording subject is extremely bright, its recorded image may turn out to be whitish.

Notes and Hints

■ White Balance

In the following cases, you cannot change White Balance:

- When you set the Picture Effect to [GAIN-UP], [SEPIA] or [MONO].
- When you set the Zoom to 15× or higher
- During Digital Still Picture Mode
- When you display a Menu

In the following cases, the [] Indication flashes:

- The flashing indicates that the previously adjusted White Balance setting is still kept. This setting will be kept until White Balance is adjusted again.
- You may not be able to achieve correct White Balance Adjustment manually under weak illumination.

■ Manual Shutter Speed Adjustment

- You may see vertical lines of light in the playback image of a brightly shining subject or highly reflective subject.
- During normal playback, movement in the images may not look smooth.
- Because the color and brightness of the playback image may become unstable, avoid recording under fluorescent light, mercury light or sodium light.
- If you are using either Gain-up Mode (-29-) or Program AE Mode (-26-), you cannot adjust the shutter speed. If the shutter speed was adjusted manually, this setting will be cancelled.

■ Manual Iris Adjustment

- Depending on zoom magnification, there are iris values that will not be displayed.
- If you are using Program AE Mode (-26-), you cannot adjust the iris.
- If you attempt to adjust the Shutter Speed after setting the Iris, the value set for the Iris will be cancelled.

■ Picture Effect Functions

- If the Picture Effect is set to [WIPE], [MIX] or [TRAIL] with [PIC.E.] Button, the setting of [NEGA], [SEPIA], [MONO] or [SOLARI] is canceled.
- If you have set the Picture Effect to [MONO] or [SEPIA], changing the selected White Balance Mode is not possible. (-27-)
- If the Picture Effect is set to [GAIN-UP], the previously adjusted shutter speed is canceled.

It is as follows when [GAIN-UP] is selected.

- Manual Focus Mode
- The shutter speed and White Balance cannot be operated.
- The Sports Mode [], the Portrait Mode [] and Low Light Mode [] are cancelled.

Wipe Mode and Mix Mode

If either one of the following operations is carried out, stored images will be erased, and Wipe and Mix Functions cannot be used.

- Use the Camera Search Function
- Press the [STILL] Button

■ Adjusting the Microphone Sensitivity Level

- When this setting is changed, the [AUDIO LEVEL] setting on the [RECORDING SETUP] Sub-Menu of the [VCR FUNCTIONS] Main-Menu will likewise be changed.
- When [ZOOM MIC] is set to [ON], set the zoom to the [T] position before performing this adjustment.
- Select a lower setting for [GAIN] or set [MIC LEVEL] to [AUTO].
- It is recommended that you check through the headphones before recording to ensure that the sound is not distorted.

■ Playing Back

Repeat Playback

If you continue to press the [▶] Button for 5 seconds or longer, the Camera Recorder switches to Repeat Playback Mode, and the [R|>] Indication appears. (To cancel Repeat Playback Mode, set the [OFF/ON] Switch to [OFF].)

Listening to Playback Sound through Headphones

If you want to use the headphones to listen to the playback sound, connect the headphones to the [PHONES] Socket (-8-) on the Camera Recorder. In this case, no sound (including a warning sound and shutter sound) will be reproduced through the built-in speaker of the Camera Recorder.

Choosing Sound during Playback

You can select the sound by using the [AUDIO OUT] setting on the [PLAYBACK FUNCTIONS] Sub-Menu. STEREO: Stereo Sound (main sound and sub sound)
L: Left channel sound (main sound)
R: Right channel sound (sub sound)

- If you dub a tape recorded at the [12bit] selected as the [AUDIO REC] on the [RECORDING SETUP] Sub-Menu, playback sound becomes stereo sound regardless of the [AUDIO OUT] setting if [12bit AUDIO] is set to [MIX].

■ Index Search Functions

- Index Search may not be possible at the beginning of tape.
- Because Photoshot Index Signals are not recorded on still pictures recorded in Continuous Photoshot Mode, the Photoshot Index Search Function cannot be used for these still pictures.
- Scene Index Search may not function properly if the interval between 2 scene index signals is shorter than 1 minute.

Notes and Hints

■ Playback Zoom Function

- You cannot adjust the sound volume with the Remote Controller in Playback Zoom Mode.
- If you turn off the Camera Recorder power or if you switch from VCR Mode to Camera Mode, Playback Zoom Mode is automatically cancelled.
- Even if Playback Zoom Functions are being used, images that are output from the DV Terminal (-8-) are not enlarged.
- As you enlarge an image, the quality of image suffers.
- During a Playback Zoom, the Variable Speed Search Function cannot be changed with the Remote Controller.

■ Playback Digital Effect Functions

- Signals of images to which digital effects are added during playback cannot be output from the DV Terminal (-8-).
- You cannot use the Wipe or Mix Function while playing back the non-recorded portion of tape.

■ Playing Back on Your TV

- If you set [AV JACK] on the [AV IN/OUT SETUP] Sub-Menu to [IN/OUT], nothing will be shown on the TV screen except during playback.

■ Audio Dubbing

- The blank section of a tape cannot be dubbed.
- Sounds sent through the DV Terminal cannot be dubbed.
- If a tape has a non-recorded portion when the tape is dubbed, images and sounds may be disturbed when this portion of the tape is played back.
- If you set the tape counter back to 0 at the position where you want to stop Audio Dubbing so as to make it possible to use the Memory Stop Function (-52-), Audio Dubbing is terminated automatically when the tape reaches this position.
- In the case of importing data recorded with Audio Dubbing to a PC using the PC's software program, only the original sound (ST1) may be imported, depending on the software program.

■ Recording the Contents of Other Equipment

Analog-Digital Conversion

- When the Camera Recorder is connected with other digital video equipment through its DV Terminal, images recorded in analog form from other external equipment can be output to the digital video equipment through the DV Terminal.
- To DV-output analog video signals sent from other equipment, set [DV OUT] on the [AV IN/OUT SETUP] Sub-Menu to [ON]. (Normally, keep the [DV OUT] set to [OFF]. If it is set to [ON], the quality of the image may be disturbed.)

■ Using the DV Cable for Recording (Digital Dubbing)

- Regardless of the setting, digital dubbing is carried out automatically in the same audio recording mode as that of the Cassette on the playback-side.
- The images on the monitor of the recording side may be disturbed, but it does not affect the recorded images.
- Even if Playback Digital Effects or Playback Zoom have been used, these effects are not output from the DV Terminal.
- Even if you use device equipped with DV Terminals (such as IEEE1394), you may not be able to perform Digital Dubbing in some cases.
- Date or other information to be displayed cannot be displayed if the software of the connected equipment does not support the display function.

Cautions for Use

■ After Use

- 1 Take out the Cassette. (-14-)
- 2 Set the [OFF/ON] Switch to [OFF].
- 3 Detach the power supply and retract the Viewfinder or the LCD Monitor. (-12-, -15-)
- 4 To protect the Lens, attach the supplied Lens Cap.

■ Cautions for Use

When you use your Camera Recorder in a rainy or snowy day or on a beach, make sure that no water enters inside the Camera Recorder.

- Water may cause the Camera Recorder or Cassette to malfunction. (Irreparable failure may occur.)
- If sea water splashes onto the Camera Recorder, wet a soft cloth with tap water, wring it well, and use it to wipe the camera body carefully. Then, wipe it again thoroughly with a soft dry cloth.

Keep the Camera Recorder away from magnetized equipment (such as a microwave oven, TV, video game equipment, etc.).

- If you use the Camera Recorder on or near a TV, images or sounds may be disturbed due to electromagnetic wave radiation.
- Do not use near a cell phone because doing so may cause noise to adversely affect the picture and sound.
- By strong magnetic fields created by speakers or large motors, recording on the tape may be damaged, or images may be distorted.
- Electromagnetic wave radiation generated by a microprocessor may adversely affect the Camera Recorder, causing the disturbance of images and sounds.
- If the Camera Recorder is affected by magnetically charged equipment and does not function properly, turn off the Camera Recorder power and detach the Battery or AC Adapter and then connect the Battery or AC Adapter again. Thereafter, turn on the Camera Recorder power.

Do not use your Camera Recorder near radio transmitters or high-voltage lines.

- If you record pictures near radio transmitters or high-voltage lines, recorded images or sounds may be adversely affected.

Do not use this Camera Recorder for surveillance purpose or other business use.

- If you use the Camera Recorder for a long period of time, the internal temperature increases and, consequently, this may cause malfunction.
- This Camera Recorder is not intended for business use.

When you use your Camera Recorder on a beach or similar place, do not let sand or fine dust get into the Camera Recorder.

- Sand or dust may damage the Camera Recorder or Cassette. (Care should be taken when inserting and removing the Cassette.)

Do not spray insecticides or volatile chemicals onto the Camera Recorder.

- If the Camera Recorder is sprayed with such chemicals, the camera body may be deformed and the surface finish may peel off.
- Do not keep rubber or plastic product in contact with the Camera Recorder for a long period of time.

Do not use benzine, thinner or alcohol for cleaning the Camera Recorder.

- The camera body may be deformed and the surface finish may peel off.
- Before cleaning, detach the Battery or pull out the AC Mains Lead from the AC mains socket.
- Wipe the Camera Recorder with a soft dry cloth. To remove stubborn stains, wipe with a cloth that is soaked in a detergent diluted with water and afterward finish wiping with a dry cloth.
- For storing or transporting the Camera Recorder, place it in a bag or case lined with soft pads so as to prevent the coating on the camera body from being worn.

After use, be sure to take the Cassette out and detach the Battery from the Camera Recorder or pull out the AC Mains Lead from AC mains socket.

- If the Cassette is left in the Camera Recorder, the tape sags and deteriorates.
- If the Battery is left on the Camera Recorder for a long time, the voltage drops excessively, and the Battery will not function even after it is recharged.

■ About AC Adapter

- If the temperature of the Battery is extremely high or extremely low, the [CHARGE] Lamp may continue flashing, and the Battery may not be charged. After the temperature of the Battery has decreased or increased sufficiently, charging starts automatically. If the [CHARGE] Lamp continues to flash even after the Battery temperature has decreased or increased sufficiently, the Battery or AC Adapter may be faulty. In this case, please contact a dealer.
- If the Battery is warm, charging takes a longer time than normal.
- If you use the AC Adapter near a radio, radio reception may be disturbed. Keep the AC Adapter 1 metre or more away from radio.
- When the AC Adapter is in use, it may generate whirring sounds. However, this is normal.
- After use, be sure to pull out the AC Mains Lead from the AC mains socket. (If they are left connected, a minute amount of current is consumed.)
- Keep the electrodes of the AC Adapter and Battery always clean.

Cautions for Use

■ Condensation

If the Condensation Indication flashes after the Camera Recorder is turned on, condensation has formed inside the Camera Recorder. In this case, the Camera Recorder power is turned off automatically after about 1 minute.

Follow the steps below:

1 Take out the Cassette.

- None of the other functions operate.
Depending on the amount of condensation, removing the Cassette may even become difficult. If this happens, wait for 2 to 3 hours before taking the Cassette out.

2 Open the Cassette Compartment Cover and wait for 2 to 3 hours.

- The number of hours to wait depends on the amount of condensation and ambient temperature.

3 2 to 3 hours later, turn on the Camera Recorder power and check to see if the Condensation Indication is displayed.

- Even if the Condensation Indication is not displayed, as a precaution, please wait for another hour before using the Camera Recorder.

Watch for Condensation even before the Condensation Indication is displayed.

- Because condensation takes place gradually, the Condensation Indication may not be displayed during the first 10 to 15 minutes of condensation formation inside the Camera Recorder.
- In extremely cold places, condensation may freeze and form frost. In this case, the frost melts first, thus forming condensation, and then it takes another 2 to 3 hours to eliminate the condensation.

When the Lens is Fogged:

Set the [OFF/ON] Switch to [OFF] and leave the Camera Recorder in this condition for about 1 hour. When the lens temperature becomes close to the ambient temperature, the fog disappears naturally.

■ Video Head Clogging and Care

If the heads (the parts that make contact with tape) are dirty, mosaic-pattern noise may appear on the playback image, or the screen as a whole becomes black. If the heads are extremely dirty, recording performance deteriorates, and, in the worst case, the Camera Recorder cannot record at all.

Causes of Dirty Heads

- Large quantity of dust in the air
- High-temperature and high-humidity environment
- Damaged tape
- Long operating hours

Using Mini-DV Format Digital Video Head Cleaner

1 Insert the Head Cleaner into the Camera Recorder in the same manner as a Video Cassette.

2 Press the [▶] Button, and approximately 20 seconds later, press the [■] Button. (Do not rewind the tape.)

3 Take out the Head Cleaner. Insert a Video Cassette and start recording. Then, play the tape back to check the recorded image.

4 If the image is not still clear, repeat Steps 1 to 3. (Do not use the Head Cleaner for 3 times or more consecutively.)

Notes:

- Do not rewind every time you use the Head Cleaner. Rewind only when the tape reaches the end, and then use it again from the beginning in the same manner as before.
- If the heads become dirty soon after cleaning, the tape may be damaged. In this case, immediately stop using that Cassette.
- Do not clean the heads excessively.
(Excessive cleaning may cause excessive wear of the heads. If the heads are worn, images cannot be played back even after the heads are cleaned.)
- If the dirty heads cannot be cleaned with the Head Cleaner, the Camera Recorder needs to be cleaned at a service center. Please consult a dealer.
- Video Head Cleaners can be purchased from service centres.
- Head cleaning due to dirty heads is not considered a malfunction of the product. It is not covered by the warranty.

Periodical Check-up

To maintain the highest image quality, we recommend replacement of worn parts, such as heads, etc., after approximately 1000 hours of use. (This, however, depends on operating conditions, such as temperature, humidity, dust, etc.)

Cautions for Use

■ Optimal Use of the Battery

Battery Characteristics

This Battery is a rechargeable lithium ion battery. Its ability to generate power is based upon the chemical reaction that takes place inside it. This reaction is susceptible to the surrounding temperature and humidity, and, if the temperature is too high or too low, the operating time of the Battery becomes shorter. If the Battery is used in an extremely cold environment, the Battery may operate only for about 5 minutes. If the Battery becomes extremely hot, a protective function may operate, and the Battery may become unusable for a while.

Be Sure to Detach the Battery after Use

Be sure to detach the Battery from the Camera Recorder. (If it is left attached to the Camera Recorder, a minute amount of current is consumed even when the Camera Recorder power is off.) If the Battery is left attached to the Camera Recorder for a long time, over discharge takes place. The Battery may become unusable after it is charged.

Disposing of an Unusable Battery

- The Battery has a limited life.
- Do not throw the Battery into fire because it may cause an explosion.

Always Keep the Terminals of the Battery Clean

Prevent the terminals from getting clogged with dirt, dust, or other substances.

If you drop the Battery accidentally, check to see if the Battery body and terminals are deformed.

Attaching a deformed Battery to the Camera Recorder or AC Adapter may damage the Camera Recorder or AC Adapter.

■ Cautions for Storage

Before storing the Camera Recorder, take the Cassette out and detach the Battery.

Store all the components in a dry place with a relatively stable temperature.

(Recommended Temperature: 15 to 25°C,
Recommended Humidity: 40 to 60%)

Camera Recorder

- Wrap it with a soft cloth to prevent dust from getting into the Camera.
- Do not leave the Camera Recorder in places that expose it to high temperature.

Battery

- Extremely high temperatures or low temperatures will shorten the life of the Battery.
- If the Battery is kept in smoky or dusty places, the terminal may rust and cause malfunctions.
- **Do not allow the Battery terminals to come in contact with metal objects (such as necklaces, hairpins, etc.). This can result in a short circuit or heat generation and, if you touch the Battery in this condition, you may be badly burned.**
- Store the Battery in a completely discharged state. To store the Battery for a long period of time, we recommend you charge it once every year and store it again after you completely use up the charged capacity.

Cassette

- Before storing it, rewind the tape to the beginning. If the Cassette is left for more than 6 months with the tape stopped midway, the tape sags (although it depends on the storage condition). Be sure to rewind to the beginning.
- Store the Cassette in its case. Dust, direct sunlight (ultraviolet rays), or humidity may damage the tape. Dust contains hard mineral particles, and dusty Cassettes damage the heads of the Camera Recorder and other components. Develop a habit of returning the Cassette back to its case.
- Once every half year, wind the tape to the end and then rewind it to the beginning. If the Cassette is left for 1 year or longer without winding or rewinding, temperature and humidity changes may cause the Cassette to deform due to swelling, shrinking, and so forth. The wound tape may stick to itself.
- Do not place a Cassette near highly magnetic substances or equipment.
- The surface of tape is covered with extremely minute magnetic particles, upon which signals are recorded. Magnetic necklaces, toys, etc., have magnetic force that is stronger than you may normally expect, and they may erase the contents of a recording or may cause noise in images and sounds.

Cautions for Use

■ LCD Monitor/Viewfinder/Lens Hood

LCD Monitor

- In a place with drastic temperature changes, condensation may form on the LCD Monitor. Wipe it with soft dry cloth.
- If your Camera Recorder is extremely cold when you turn its power on, the image on the LCD Monitor is slightly darker than usual at first. However, as the internal temperature increases, it goes back to the normal brightness.

Extremely high precision technology is employed to produce the LCD Monitor screen featuring a total of approximately 112,000 pixels. The result is more than 99.99% effective pixels with a mere 0.01% of the pixels inactive or always lit. However, this is not a malfunction and does not affect the recorded picture.

Viewfinder

- Do not direct the Viewfinder or Lens to the sun. Internal components may be seriously damaged.
- To clean the inside of the Viewfinder, remove the Eyecup ①, then keep pressing ② and pull the cover ③ out.

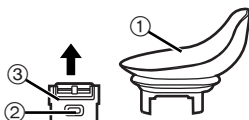

Extremely high precision technology is employed to produce the Viewfinder screen featuring a total of approximately 113,000 pixels. The result is more than 99.99% effective pixels with a mere 0.01% of the pixels inactive or always lit. However, this is not a malfunction and does not affect the recorded picture.

Lens Hood

- Do not attach other conversion lenses in front of the Lens Hood; there is no mount to be used for the attachment.
- When you wish to attach the Wide Conversion Lens (VW-LW4307ME; optional), MC Protector, or ND Filter in the Filter Kit (VW-LF43WE; optional), first of all, loosen the Lens Hood Attachment knob ①. If the MC Protector or ND Filter is used, the Lens Hood can be mounted on the filter.
- When you attach the Lens Hood back, unite the marks and fasten the Lens Hood Attachment knob ①.

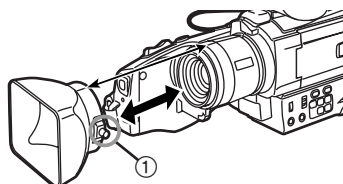

- If you push the [W/T] Lever toward [W] during recording with the filter or conversion lens attached to the Camera Recorder, 4 corners of the image may become dark (vignetting). For details, please refer to the operating instructions of your accessories.
- Be sure to keep the Lens Hood attached to the Camera Recorder so as to shut out unnecessary light.

Before Requesting Repair (Problems and Solutions)

Power

- 1: The Camera Recorder power cannot be turned on.**
 - Is the power source connected correctly? (-12-)
- 2: The Camera Recorder power is turned off automatically.**
 - If you leave the Camera Recorder in Recording Pause Mode for more than 5 minutes, the power is turned off automatically to protect the tape and to save the Battery power. (-20-)
- 3: The Camera Recorder power does not stay on long enough.**
 - Is the Battery low? Charge the Battery or attach a fully charged Battery. (-12-)
 - Has condensation occurred? Wait until the Condensation Indication disappears. (-47-)

Battery

- 1: Battery runs down quickly.**
 - Is the Battery fully charged? Charge it with the AC Adapter. (-12-)
 - Are you using the Battery in an extremely cold place? In cold places, the operating time of the Battery becomes shorter. (-48-)
 - Has the Battery worn out? If the operating time is still too short even after the Battery is fully charged, the Battery has worn out.
- 2: The Battery cannot be charged.**
 - If the DC Input Lead is connected to the AC Adapter, charging cannot be performed. Disconnect the DC Input Lead.

Normal Recording

- 1: Recording does not start although power is supplied to the Camera Recorder and the Cassette is correctly inserted.**
 - Is the accidental erasure prevention slider on the Cassette open? If it is open (set to [SAVE]), recording cannot be performed. (-14-)
 - Is the tape wound to the end? Insert a new Cassette. (-14-)
 - Is the Camera Recorder power turned on? (-20-)
 - Is the [CAMERA] Lamp on? If the [CAMERA] Lamp is not on, no recording function can be operated. (-20-)
 - Has condensation occurred? Wait until the Condensation Indication disappears. (-47-)

Other Recording

- 1: Auto Focus Function does not work.**
 - Is Manual Focus Mode selected? If Auto Focus Mode is selected, focus is automatically adjusted. (-29-)
 - There are some recording subjects and recording surroundings for which the Auto Focus Function does not operate correctly. In this case, use the Manual Focus Mode to adjust the focus. (-52-)

Editing

- 1: Audio dubbing cannot be performed.**
 - Is the accidental erasure prevention slider on the Cassette open? If it is open (set to [SAVE]), recording cannot be performed. (-14-)
 - Are you attempting to edit a tape portion that was recorded in LP Mode? LP Mode does not allow audio dubbing to operate. (-18-)

Indications

- 1: The Time Code becomes inaccurate.**
 - The Time Code Indication counter may not be constant in the reverse direction in Slow Motion Playback Mode, but this is not a malfunction.
- 2: The Remaining Tape Time Indication disappears.**
 - When you record still pictures in Photoshot Mode, the Remaining Tape Time Indication may disappear temporarily. However, it reappears when recording normally.
- 3: The Remaining Tape Time Indication does not match the actual remaining tape time.**
 - If scenes of less than 15 seconds are continuously recorded, the remaining tape time cannot be displayed correctly.
 - In some cases, the Remaining Tape Time Indication may show remaining tape time that is 2 to 3 minutes shorter than the actual remaining tape time.

Playback (Pictures)

- 1: Pictures cannot be played back even when the [▶] Button is pressed.**
 - Is the [VCR] Lamp on? If the [VCR] Lamp is not on, the playback function cannot be used. (-32-)
- 2: Mosaic-pattern noise appears on images during Cue, Review or Slow Motion Playback.**
 - This phenomenon is characteristic of digital video systems. It is not a malfunction.
- 3: Although the Camera Recorder is correctly connected to a TV, playback images cannot be seen.**
 - Have you selected "Video Input" on the TV? Please read the operating instructions of your TV and select the channel that matches the input sockets used for the connection.

4: Playback picture is not clear.

- Are the heads of the Camera Recorder dirty? If the heads are dirty, playback image cannot be clear. (-47-)

Before Requesting Repair (Problems and Solutions)

Playback (Sound)

1: Sound is not played back from the built-in speaker of the Camera Recorder or the headphones.

- Is the volume too low? During playback, keep pressing the [PUSH] Dial until the [VOLUME] Indication appears. Then, turn the [PUSH] Dial to adjust the volume. (-32-)

2: Different sounds are reproduced at the same time.

- [12bit AUDIO] on the [PLAYBACK FUNCTIONS] Sub-Menu of the [VCR FUNCTIONS] Main-Menu has been set to [MIX]. As a result, the original sound and sound that was recorded by audio dubbing are played back together. It is possible to reproduce the sounds separately. (-38-)

3: The original sound was erased when audio dubbing was performed.

- If you perform audio dubbing on a recording done in [16bit] Mode, the original sound will be erased. If you wish to preserve the original sound, be sure to select [12bit] Mode at the time of recording.

4: Sounds cannot be played back.

- Although a Cassette with no audio dubbing is being played, is [12bit AUDIO] on the [PLAYBACK FUNCTIONS] Sub-Menu of the [VCR FUNCTIONS] Main-Menu set to [ST2]? To play back a Cassette with no audio dubbing, [12bit AUDIO] must be set to [ST1]. (-38-)
- Is the Variable Speed Search Function working? Press the [▶] Button to cancel the Variable Speed Search Function. (-33-)

Explanation of Terms

■ Digital Video System

In a digital video system, images and sounds are converted into digital signals and recorded on a tape. This complete digital recording is capable of recording and playback with minimal image and sound deterioration.

In addition, it automatically records data, such as Time Code and Date/Time, as digital signals.

Compatibility with S-VHS or VHS Cassettes

Because this Camera Recorder employs a digital system for recording image and sound data, it is not compatible with conventional S-VHS or VHS video equipment that employs an analog recording system. The size and shape of the Cassette are also different.

Compatibility with Output Signals

Because AV signal output from the AV signal output socket is analog (the same as conventional video systems), this Camera Recorder can be connected with S-VHS or VHS video or a TV for playback.

■ Focus

Auto Focus Adjustment

The Auto Focus System automatically moves forward and backward the focusing lens inside the Camera Recorder to bring the subject into focus so that the subject can be seen clearly.

However, the Auto Focus System does not function properly for the following subjects or under the following recording conditions.

Please use the Manual Focus Mode instead.

1) Recording a subject whose one end is located closer to the Camera Recorder and the other end farther away from it

- Because Auto Focus makes adjustments at the center of an image, it may be impossible to focus on a subject that is located in both foreground and background.

2) Recording a subject behind dirty or dusty glass

- Because the focus is on the dirty glass, the subject behind the glass will not be focused.

3) Recording a subject in dark surroundings

- Because the light information that comes through the lens decreases considerably, the Camera Recorder cannot focus correctly.

4) Recording a subject that is surrounded by objects with glossy surfaces or by highly reflective objects

- Because the Camera Recorder focuses on the objects with glossy surfaces or on highly reflective objects, the recording subject may become blurry.

5) Recording a fast-moving subject

- Because the focus lens-inside moves mechanically, it cannot keep up with the fast-moving subject.

6) Recording a subject with little contrast

- Because the Camera Recorder achieves focus based upon the vertical lines of an image, a subject with little contrast, such as a white wall, may become blurry.

■ Time Code

Time Code signals are data that indicate time measured in hours, minutes, seconds, and frames (30 frames per second). If this data is included in a recording, an address is assigned to each image on the tape.

- The Time Code is automatically recorded as a part of the sub-code at each recording.
- When a new (previously unrecorded) Cassette is inserted, the Time Code automatically starts from zero. If a recorded Cassette is inserted, the Time Code picks up from the point where the last scene was recorded. (In this case, when the Cassette is inserted, the zero display [0h00m00s00f] may appear, but the Time Code starts from the previous value.)
- The Time Code cannot be reset to zero.
- Unless the Time Code is continuously recorded from the beginning of a tape, accurate editing may not be possible. To ensure that the Time Code will be recorded with no breaks, we recommend the use of the Camera Search Function (-20-) or the Blank Search Function (-34-) before recording a new scene.

■ Memory Stop Function

The Memory Stop Function is useful for the following operations.

Rewinding or fast-forwarding a tape to a desired position

1 Set [DISPLAY SETUP] >> [C.DISPLAY] >> [MEMORY].

2 Reset the Tape Counter to zero at the tape position from which you want to play it back later. (-11-, -16-)

3 Start playback or recording.

4 After playback or recording has finished: Press the [MODE] Button and set the Camera Recorder to VCR Mode.

- The [VCR] Lamp lights up.

5 Rewind the tape.

- The tape automatically stops approximately at the position where the counter was set to zero.

Stopping editing automatically during audio dubbing

1 Set [DISPLAY SETUP] >> [C.DISPLAY] >> [MEMORY].

2 Reset the Tape Counter to zero at the position where you want to stop editing.

3 Play back the still picture where you want to start audio dubbing.

4 Start audio dubbing. (-38-)

- Audio dubbing automatically stops at the position where the counter was set to zero.

Specifications

[Digital Video Camera]

Information for your safety

Power Source: DC 7.2 V (Battery)
DC 7.9 V (AC adapter)

Power consumption:

Recording
3.2 W (When using Viewfinder)
4.0 W (When using LCD Monitor)
6.5 W (Max.)

 indicates safety information.

Recording Format:

Mini DV (Consumer-use Digital Video SD Format)

Tape Used:

6.35 mm digital video tape

Recording/Playback Time:

SP: 80 min.; LP: 120 min. (with DVM80)

Video

Recording System:

Digital Component

Television System:

525 lines, 60 fields NTSC color signal

Audio

Recording System:

PCM Digital Recording
16 bit (48 kHz/2ch), 12 bit (32 kHz/4ch)

Image Sensor:

1/4-inch CCD Image Sensor

Lens:

Auto Iris, F1.8, Focal Length; 3.1–46.5 mm,
Macro (Full Range AF)

Filter Diameter:

43 mm

Zoom:

15:1 Power Zoom

Monitor:

2.5-inch LCD

Viewfinder:

Color Electronic Viewfinder

Microphone:

Stereo

Speaker:

1 round speaker (20 mm diameter)

Standard Illumination:

1,400 lx

Minimum Required Illumination:

1 lx (Digital Gain-up Mode)

Video Output Level:

1.0 V [p-p], 75 Ω

S-Video Output Level:

Y Output: 1.0 V [p-p], 75 Ω
C Output: 0.286 V [p-p], 75 Ω

Audio Output Level (Line):

316 mV, 600 Ω

Video Input Level:

1.0 Vp-p, 75 Ω

S-Video Input Level:

Y Input: 1.0 V [p-p], 75 Ω
C Input: 0.286 V [p-p], 75 Ω

Audio Input Level (Line):

316 mV, 10 kΩ or more

Mic Input:

Mic sensitivity –50 dB (0 dB=1 V/Pa, 1 kHz)
(Stereo mini jack)

Digital Interface:

DV Input/Output Terminal (IEEE1394, 4-pin)

Dimensions (W×H×D)

Approx. 8 7/16×8 7/8×17 1/16 inch
(213×225×432 mm)

Weight

Approx. 4.4 lb (2.0 kg)
(without Battery and DV cassette)
Approx. 4.62 lb (2.1 kg)
(with supplied Battery and DVM60)

Operating Temperature:

32°F to 104°F (0°C to 40°C)

Operating Humidity:

10% to 80%

[AC Adapter]

Information for your safety

Power Source: 110/120/220/240 V AC, 50/60 Hz

Power consumption:

18 W

DC Output:

DC 8.4 V, 1.2 A (Charge)
DC 7.8 V, 1.4 A Max. (Camera Recorder)

 indicates safety information.

Dimensions (W×H×D)

2 13/16×1 13/16×4 5/8 inch
(70×44.5×116 mm)

Weight

0.35 lb (0.16 kg)

Weight and dimensions are approximate values.
Specifications may change without prior notice.

Panasonic

PANASONIC BROADCAST & TELEVISION SYSTEMS COMPANY
UNIT COMPANY OF MATSUSHITA ELECTRIC CORPORATION OF AMERICA

Executive Office:

One Panasonic Way 4E-7, Secaucus, NJ 07094 (201) 348-7000

EASTERN ZONE:

One Panasonic Way 4E-7, Secaucus, NJ 07094 (201) 348-7621

Southeast Region:

1225 Northbrook Parkway, Ste 1-160, Suwanee, GA 30024 (770) 338-6835

Central Region:

1707 N Randall Road E1-C-1, Elgin, IL 60123 (847) 468-5200

WESTERN ZONE:

3330 Cahuenga Blvd W., Los Angeles, CA 90068 (323) 436-3500

Government Marketing Department:

52 West Gude Drive, Rockville, MD 20850 (301) 738-3840

Broadcast PARTS INFORMATION & ORDERING:

9:00 a.m. – 5:00 p.m. (EST) (800) 334-4881/24 Hr. Fax (800) 334-4880

Emergency after hour parts orders (800) 334-4881

TECHNICAL SUPPORT:

Emergency 24 Hour Service (800) 222-0741

Panasonic Canada Inc.

5770 Ambler Drive, Mississauga, Ontario L4W 2T3 (905) 624-5010

Panasonic de Mexico S.A. de C.V.

Av angel Urraza Num. 1209 Col. de Valle 03100 Mexico, D.F. (52) 1 951 2127

Panasonic Sales Company

Division of Matsushita Electric of Puerto Rico Inc.

San Gabriel Industrial Park, 65th Infantry Ave., Km. 9.5, Carolina, Puerto Rico 00630 (787) 750-4300